



Beta

Action

www.beta-tools.com



**Promoție valabilă
până la 31/12/2021**

Prețurile sunt exprimate în EURO
și nu includ TVA

ISTORIA BETA TOOLS

1923 - Alessandro Ciceri a fondat "Alessandro Ciceri & Figli", fabrica si turnatorie de piese din fonta si otel.

1939 - Logo-ul Beta a fost inregistrat si Compania a devenit implicata in productia de scule profesioanle.

1960 - Beta Utensili avea 200 de angajati, a inceput exportul, devenind recunoscuta ca producator de scule profesionale.

1969 - A fost proiectat si realizat emblematicul dulap de scule portocaliu "Tank"; din acel moment culoarea portocalie a devenit sinonim cu stilul si brand-ul Beta.

1971 - Beta Utensili a intrat in lumea motorsportului, dezvoltind si testind o serie intreaga de noi produse..

1975 - Prima victorie in Formula 1 cu monopostul portocaliu pilotat de Vittorio Brambilla, castigind Austrian Grand Prix in Zeltweg, in timpul unei curse desfasurate pe ploaie.

1980 - Beta Utensili avea deja o retea foarte bine dezvoltata de importatori si distribuitori in intreaga Europa.

1995 - Dupa 8 luni de verificari si incercari Beta Utensili a obtinut certificatul Quality System in concordanta cu standardele de calitate ISO 9001.

2000 - Odata cu lansarea noului catalog a fost recunoscuta cresterea permanenta a gamei de produse.

Peste 10,000 de coduri diferite divizate in peste 20 de categorii.

2002 - A aparut noua gama de pantofi de lucru si haine de productie in portofoliu Beta Utensili, denumita "Beta Work".

2009 - Beta a continuat cresterea si a fondat Beta China.

2012 - Beta Brazil a fost deschisa.

2016 - Beta introduce noul sistem modular pentru dulapuri si bancuri de lucru.

2018 - In 2018 BM S.p.A - lider in productia si distributia de scule electrice a devenit parte din Beta Group.

2019 - Cresterea continua este vizibila prin gama de produse existenta - distribuita la nivel mondial - constind in peste 12.000 de produse diferite, proiectate si realizate pentru a respecta standardele de calitate cerute de profesionisti.



1939 Sectia de forjare



1950 Sectia de galvanizare



1955 Sectia de debitare si ambutisare



1960 Depozit pentru livrare



1969 Dulapul mobil tip "Tank"



1975 Sectia de cromare



1974 Vittorio Brambilla



1980 Sectia de prelucrare



1981 Lansarea de noi seturi de scule



2002 "BetaWork"



2016 Noua gama de mobilier RSC55



2018 Fabio Quartararo

BETA UTENSILI S.p.A. - 20845 Sovico (MB)
Via A. Volta, 18 - Tel. 039.2077.1 - Telefax 039.2010742
www.beta-tools.com

Robur Wire rope accessories: 67039 Sulmona (AQ)
Zona industriale - C.da S. Nicola - Tel. 0864.2504.1 - Telefax 0864.253132
www.roburitaly.com - info@roburitaly.com

1939



1950



1960



1970



1980





Sovico (Monza Brianza)

3 FABRICII DE PRODUCȚIE

- **Peste 500** angajați
- **100.000** metri pătrați, dintre care 32.000 acoperiți
- **Peste 10 milioane** de scule fabricate în fiecare an



Castiglione



Sulmona (L'Aquila)



GAMA ȘI PRODUSE

Peste 15,000 de produse

Creșterea susținută a ajutat la crearea unei game de produse care să țină pasul cu diversificarea cererii la nivel global.

Astăzi, gama de scule Beta cuprinde peste 15,000 de repere diferite care formează 26 de categorii distincte, ajungând astfel una dintre cele mai profesionale branduri în domeniul producătorilor de scule.

Beta produce scule pentru mecanicii profesioniști, din toate domeniile, începând cu cel auto până la cel industrial, și pentru toți cei care cred că un hobby este mai mult decât un mod de a pierde timpul.

26

categorii

*Avem o soluție
pentru fiecare
profesionist*

Aplicații



Automotive



Energie



Industrie



Oil & Gas



Aeronautic

Beta RSC55



**Configurează online
mobilerul de lucru
din atelierul tău**

WWW.RSC55.COM

www.youtube.com/

www.betatools.com



O soluție pentru fiecare nevoie...



Certified quality

In 2018 dulapurile Beta au obtinut prestigiosul certificat de calitate Tuv, dupa ce a fost testat de mai multe ori conform normelor EK5/TA5.

Aceste norme urmăresc respectarea a 31 de caracteristici bine definite, testările fiind atât statice cât și dinamice.

Alte încercări determină rezistența la temperaturi foarte joase sau foarte înalte, rezistența marcajelor în timp și rezistența anti-corozivă.

Respectarea acestor standarde de calitate se datorează experienței îndelungate în proiectarea, producția și testarea la care sunt supuse toate produsele Beta, reușind astfel sa fie cunoscute și apreciate de toți utilizatorii.

kg
1200



C39

kg
1000



C33

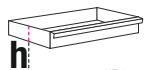
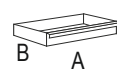
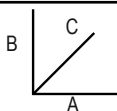

↓ max
30 kg
35 kg
35 kg



800 x 971 x 500 mm

807 x 1016 x 500 mm

6 59 kg	7 61 kg	8 64 kg	6 69 kg	7 71 kg	8 73 kg
------------	------------	------------	------------	------------	------------

588 x 367 mm

588 x 367 mm

6	7	8	6	7	8
4 x h 70 mm	5 x h 70 mm	6 x h 70 mm	4 x h 75 mm	5 x h 75 mm	6 x h 75 mm
1 x h 140 mm	1 x h 140 mm	2 x h 140 mm	1 x h 150 mm	1 x h 150 mm	2 x h 150 mm
1 x h 280 mm	1 x h 210 mm	-	1 x h 305 mm	1 x h 225 mm	-

componente de scule recomandate

290 PT (290 /)	18			✓		✓
230 PT (230 /)	16	✓	✓	✓	✓	✓
260 PT (260 /)	17	✓	✓	✓	✓	✓
300 PT (300 /)	19					

Alege dulapul care se potrivește cerințelor tale !

kg
800



kg
1100



kg
1100



kg
1000



C24S

C24SL-CAB

C24SL

C24SA-XL



RAL 2011

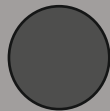

RAL 7016



RAL 3000



740 x 955 x 445 mm

1050 x 973 x 565 mm

1050 x 973 x 565 mm

1035 x 970 x 445 mm

6
55 kg

7
58 kg

8
61 kg

82 kg

80 kg

7
84 kg

8
88 kg

9
92 kg

588 x 367 mm

588 x 367 mm

588 x 367 mm

882 x 367 mm

6

7

8

7

7

7

8

9

4 x h 70 mm
1 x h 140 mm
1 x h 280 mm

5 x h 70 mm
1 x h 140 mm
1 x h 210 mm

6 x h 70 mm
2 x h 140 mm
-

5 x h 70 mm
1 x h 140 mm
1 x h 210 mm

5 x h 70 mm
1 x h 140 mm
1 x h 210 mm

5 x h 70 mm
1 x h 140 mm
1 x h 210 mm

6 x h 70 mm
2 x h 140 mm
-

8 x h 70 mm
1 x h 140 mm
-



MOBILIER MODULAR GARAJ FORMAT DIN:
C55PRO BO/2

- Banc de lucru modular
 Cu blat de lucru (2050x700 mm) acoperit
 cu un strat de ABS detasabil
- Priză Schuko +16+10A
 - Priză EU 16+10A
 - Suport rolă furtun aer comprimat Ø 8 mm. Lungime: 10 m
- Gauri pentru menghina (1599F/150, se achiziționează separat)

C55C7

- Dulap mobil modular cu 7 sertare
 (588x367 mm) cu rulmenți
- 4 roți Ø 100 mm, 2 fixe (una cu sistem blocare) și 2 pivotante
 - Deschidere din aluminiu pe toată suprafața sertarului
 - Sertare protejate cu garnituri din spumă de cauciuc
 - Închidere centralizată frontală
 - Se pot dota cu suporturi termoformate de scule

C55M7

- Modul fix format din 7 sertare
 (588x367 mm) cu rulmenți
- Deschidere din aluminiu pe toată suprafața sertarului
 - Sertare protejate cu garnituri din spumă de cauciuc
 - Închidere centralizată frontală
 - Se pot dota cu suporturi termoformate de scule

C55PB-PRO/5

055000025

~~€ 6390~~ **€ 3690**
Banc de lucru cu panoplie

- Livrat cu suport susținere panoplie
- Panoplie cu jaluza din aluminiu cu încuietoare
- Interior din tablă perforată pe care se pot agăța scule

 2000 mm
 760 mm
 2050 mm

 346 kg
C55M7
C55C7
C55PRO BO/2

Dimensiuni sertar potrivite pentru module din plastic și burete pentru C24, vezi pag.12-13



Priză Schuko +16+10A
 Priză EU 16+10A



Sistem de roți special realizat pentru scoaterea cu ușurință de sub banc



leșire aer comprimat și rolă Ø 8 mm.
 Lungime: 10 m

MOBILIER MODULAR GARAJ C45

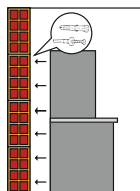

Format din:

- Modul fix format din 7 sertare (C45M7)
- Modul fix service (C45MS)
- Dulap mobil cu 7 sertare (C45C7)
- Dulap cu 2 uși (C45AS2)
- 3 panouri perforate pentru scule (C45PF)
- 3 rafturi suspendate (C45PM)
- Suport perete lat, 3 bucăți (C45SL)
- Suport perete îngust, 1 bucată (C45SS)



▶ **305 kg**

C45/X

045000010

~~€ 3150~~ **€ 1890**

Banc de lucru modular cu blat din MDF și oțel inoxidabil (C45PX/3-2,0MT)

C45/W

045000020

~~€ 3060~~ **€ 1790**

Banc de lucru modular, cu blat din lemn stratificat (C45PW/3-2.0MT)



▶ **303 kg**



2000 mm
495 mm
2955 mm

MOBILIER MODULAR C45

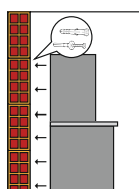

Format din:

- Modul fix format din 5 sertare (C45M5)
- Modul fix 2 uși (C45MA)
- Dulap 1 ușă (C45AS1)
- 2 panouri perforate pentru scule (C45PF)
- 2 rafturi suspendate (C45PM)
- Suport perete lat, 2 bucăți (C45SL)
- Suport perete îngust, 1 bucată (C45SS)

C45/BW

045000053

Banc de lucru modular, cu blat din lemn stratificat (C45PW/3-2.0MT)

~~€ 1870~~ **€ 1090**

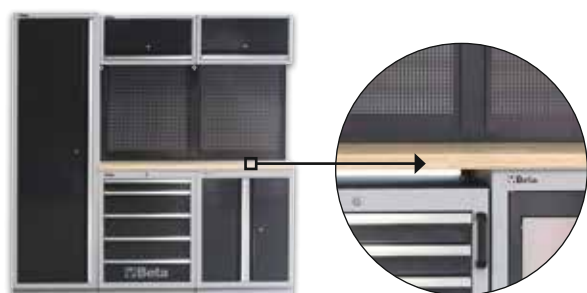

▶ **190 kg**



▶ **191 kg**

2000 mm
495 mm
1960 mm

C45/BX

045000043

Banc de lucru modular atelier, blat din MDF și oțel inoxidabil (C45PX/2-1.3MT)

~~€ 1955~~ **€ 1190**

C51

051000001

051000002

051000003

~~€ 217~~
€ 139
Cărucior cu 3 polițe

- 3 polițe acoperite cu cauciuc anti-alunecare.
- Două variante de fixare pentru suprafața de lucru centrală.
- Patru roți Ø 100 mm: 2 fixe și 2 orientabile (cu 1 frână).
- Capacitate de susținere: 200 kg (distribuite pe cele 3 rafturi).

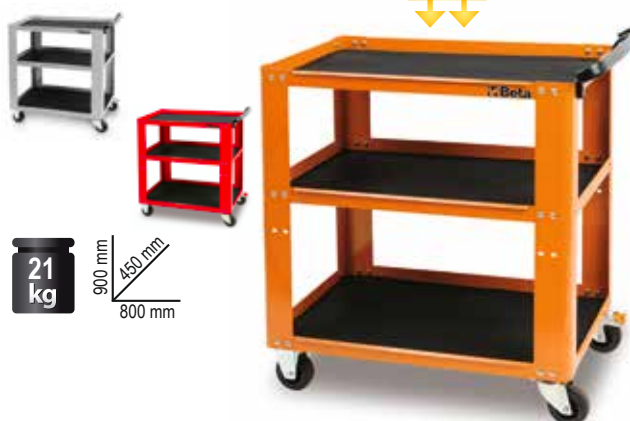
200 kg

21 kg
 900 mm
 450 mm
 800 mm

CP51

051000501

051000502

051000503

~~€ 285~~
€ 199
Cărucior mobil cu 2 polițe

- 2 polițe acoperite cu cauciuc anti-alunecare.
- Mâner ergonomic.
- Patru roți Ø 125 mm: 2 fixe și 2 orientabile (cu 1 frână).
- Capacitate de susținere: 750 kg (distribuite pe cele 2 polițe).

750 kg

37 kg
 900 mm
 500 mm
 870 mm

CX49-G

049000102

Dulap multifuncțional
~~€ 570~~
€ 360
poate fi folosit ca post de lucru mobil cu dispozitive pentru diagnoză, laptop, testere, încărcătoare de baterii

- Structură metalică, cu un sertar pentru tastatură și două polițe fixe, ajustabile pe înălțime
- Mâner ergonomic
- 2 roți fixe Ø 160 mm
- 2 roți orientabile Ø 125 mm

36 kg
 1099 mm
 460 mm
 435 mm

C24S/7

024002071

024002072

024002073

024002079

024002076

Dulap mobil cu 7 sertare

- 7 sertare (588x367 mm) cu glisieră pe rulmenți.
- Baza sertarelor protejate cu covorașe din spumă de cauciuc.
- 4 roți cu Ø 125 mm: 2 fixe și 2 orientabile (cu o frână).
- Închidere centralizată frontală.
- Blat din material termoplastice foarte rezistent, destinat lăzilor de scule C22S, C23S, C23SC și C23ST
- Suport lateral pentru recipiente.
- Poate fi dotat cu suport rolă hârtie 2400S-R/PC.

€ 800,00

€ 450

800 kg

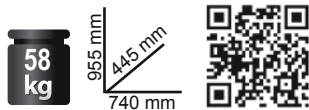

n°	h	max
5	70 mm	25 kg
1	140 mm	30 kg
1	210 mm	30 kg

Dotare standard



Roți din oțel

pentru rezistență
mărită



Blat de lucru din

termoplastice foarte
rezistent



Sertare cu glisieră

pe rulmenți



Suport recipiente

inclus



C23ST

023000521

023000522

023000523

Cutie portabilă cu 5 sertare

- 5 sertare (588x367 mm) cu sistem de culisare pe rulmenți
- Închidere centralizată
- se poate dota cu un cărucior cu 4 roți și mâner

€ 542,00

€ 360

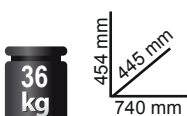

n°	h	max
5	70 mm	25 kg



C24SA-XL

C24SA-XL/7
C24SA-XL/9

024002271
024002331

024002272
024002332

024002273
024002333

Dulap mobil model extra-lung, cu sistem antirăsturnare

- 7 sertare (882x367 mm) cu glisiere pe rulmenți.
- Blat din ABS solid, cu 6 locașuri.
- Parte frontală rezistentă, din plastic special,
- Baza sertarelor protejate cu covorașe din spumă de cauciuc.
- 4 roți cu Ø 125 mm: 2 fixe și 2 orientabile (cu o frână).
- Închidere centralizată frontală.
- Suport lateral pentru recipiente.

970 mm
445 mm
1035 mm

84 kg

n°	h	max
5	70 mm	30 kg
1	140 mm	35 kg
1	210 mm	35 kg

882 mm



extra-lung

C24SA-XL/7	€ 1.075	€ 660
C24SA-XL/9	€ 1.220	€ 770



Se poate dota cu 6 seturi de scule în suport

C24SL-CAB

Dulap mobil cu 7 sertare, blat de lemn și 2 etajere laterale cu închidere

- 7 sertare (588x367 mm) cu glisiere pe rulmenți:
- Sertare cu protecție din spumă cauciuc.
- 4 roți, Ø 125 mm: 2 fixe și 2 orientabile (cu frână).
- Închidere centralizată
- Blat de lucru din lemn stratificat, prevăzut cu locaș pentru menghină (1599F/100, se comandă separat).
- Suport încorporat pentru rolă hârtie
- Suport dublu pentru recipiente în partea din spate

970 mm
565 mm
1050 mm

80 kg



n°	h	max
5	70 mm	25 kg
1	140 mm	30 kg
1	210 mm	30 kg



€ 1.225 € 720

024002191

024002192

024002193



C56

Banc de lucru

- Blat de lucru din tablă vopsită în câmp electrostatic.
- Cadru de oțel cu 6 picioare de sprijin.
- Două sertare cu încuietori.
- Se poate fixa pe pardoseală.



930 mm
840 mm
2000 mm

82 kg

056000201

056000202

056000203

1200 kg

~~€ 775~~

€ 480



Suport prindere in podea

C56B

Banc de lucru cu blat de lemn

- Blat de lucru din lemn stratificat, cu găuri pentru menghină 1599F/125 (se va comanda separat).
- Cadru din oțel cu 4 picioare susținere
- Raft inferior pentru depozitare
- Se poate fixa în pardoseală



930 mm
720 mm
2000 mm

54,5 kg

056000401

056000402

056000403

800 kg

~~€ 515~~

€ 299



Suport prindere in podea

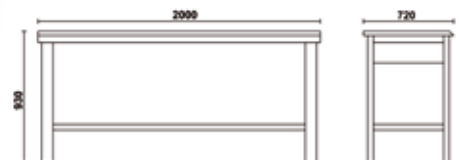

1599P

Menghină paralelă de banc

- lățime fălci 125 mm
- deschidere maximă 130mm



015990025

~~€ 287~~

€ 199

C56P 0

056000011

Banc de lucru pliabil

Blat cu o grosime de 30mm făcut din MDF și tablă de fier galvanizat; poate fi folosit pe ambele părți.
Mâner cu protecție din cauciuc pentru transport ușor.
Picioare antiderapante.

~~€ 345~~

€ 220



COMPACT ȘI USOR DE TRANSPORTAT

25 kg

CB52-0

052000201

Banc de lucru mobil, cu sistem de recuperare a lichidelor

Prevăzut cu plan înclinat și găuri de scurgere către tancul de colectare

Echipat cu:

- 4 roți orientabile, incluzând 2 cu frână
- sertar pentru scule
- tanc de colectare tip sertar, capacitate 7 l
- poliță inferioară

~~€ 540~~

€ 330

400 kg



60 kg

870 mm
640 mm
1200 mm

C50S

050000301

050000302

050000303

Cărucior pentru scule prevăzut cu 3 sertare

~~€ 430~~

€ 269

- Blat de lucru termoplastic
- 3 sertare (588x367 mm) cu glisiere cu rulmenți cu bile, înălțime de 70 mm
- Bazele sertarelor protejate de covoare din cauciuc spumat
- Încuietoare de siguranță centralizată față
- Suport lateral pentru șurubelniță inclus
- Două suporturi laterale încorporate pentru recipiente
- Raft mare inferior protejat de un covor anti-ulei și anti-cauciuc
- Patru roți, Ø 125 mm:
- 2 fixe și 2 de direcție (una cu frână)
- Capacitate de încărcare statică: 400 kg
- Capacitatea fiecărui sertar: 15 kg, distribuită uniform
- Suportul pentru role de hârtie articolul 2400S-R / PC poate fi aplicat (se comandă separat)



SUPPORT ȘURUBELNIȚĂ INCLUS

C28

028000301

028000302

028000303

Dulap mobil SUPERTANK cu blat de lemn și 10 sertare

~~€ 2110~~

€ 1290

- 10 sertare (588x367 mm) pe rulmenți.
- Sistem rapid și sigur de deschidere și închidere a sertarelor, cu parte frontală din nailon și fibră de sticlă.
- 5 sertare laterale.
- 5 sertare frontale.
- Baza sertarelor protejate cu covorașe din spumă de cauciuc.
- 4 roți de mare capacitate cu Ø 150 mm: 2 fixe și 2 orientabile (cu frâne).
- 2 încuietori frontale.
- Blat de lucru din lemn multistratificat, cu găuri pentru menghină (1599F/150 se va comanda separat)
- Compartiment lateral cu ușă rabatabilă cu încuietoare.
- Compartiment de depozitare de 135 mm înălțime, cu bază acoperită de plastic rezistent ABS.



Sistem rapid și sigur pentru deschiderea și închiderea sertarelor

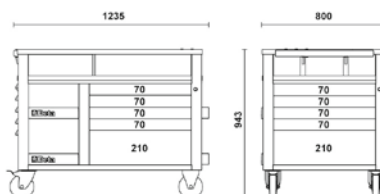

T91

024240091

~~€ 190,00~~ € 89

Set chei tubulare 1/4"



1/4"

- 900 4-4,5-5-5,5-6
7-8-9-10-11-12
13-14 mm
- 900ME 2,5-3-4-5-6-8 mm
- 900/20 50 mm
- 900/21 150 mm
- 900/25
- 900BG/30 176 mm
- 900/42 115 mm
- ⊗ 900/55 125 mm



T92

024240092

~~€ 242,00~~ € 99

Set chei tubulare 3/8"



3/8"

- 910A 6-7-8-9-10-11-12
13-14-15-16-17-18
19-20-21-22 mm
- 910/21 125 mm
- 910/22 250 mm
- 910/25
- 910/42 210 mm
- ⊗ 910/55 200 mm



T103

024240103

~~€ 254,00~~ € 99

Set chei tubulare lungi



1/2" 1/4"

- 900L 6-7-8-9-10
11-12 mm
- 920AL 13-14-16-17
18-19-21-22
24-27 mm



T40

024240040

~~€ 86,50~~ € 45

Set chei inelare cotite



- 90 6x7-8x9-10x11-12x13
14x15-16x17-18x19 mm



T41

024240041

~~€ 128,50~~ € 75

Set chei inelare cotite



- 90 20x22-21x23-24x26
25x28-27x29 mm



T112

024240112

~~€ 250,00~~ € 99

Set chei tubulare Torx



1/2" 1/4"

- 861TX ● T6÷T15
- 866TX ● T20÷T55
- 895/1 ○ 1/4x □ 1/4
- 895/6 ○ 5/16x □ 1/2
- 900FTX □ E4÷E10
- 920FTX □ E12÷E24
- 920TX □ T55L-T60-T70L



T201

024240201

~~€ 52,50~~ € 36

Set șurubelnițe drepte



- 1260 8x200
10x150
10x200 mm
- 1260 4x30
6,5x30 mm

Beta GRIP



T204

024240204

~~€ 43,50~~ € 29

Set șurubelnițe Ph



- ⊕ 1262 PH3x150
PH4x200 mm
- ⊕ 1262N PH1x30
PH2x30 mm

Beta GRIP



T207

024240207

~~€ 77,00~~ € 49

Set șurubelnițe Torx



- ⊕ 1268RTX T9 - T10
T15 - T20
T25 - T27
T30

Beta GRIP



T209

024240209

~~€ 63,00~~ € 43,50

Set șurubelnițe extra-lungi



- ⊕ 1262L PH1x400 - PH2x400 mm
- ⊕ 1264L 3x300 - 4x400 - 5x400 mm



Set scule în suport termoformat

T106

024240106

~~€ 266,00~~ € 169

Set cheie clichet și accesorii 3/4"

3/4"



928/21 200 mm 928/42 450 mm
928/22 380 mm 928/55 510 mm

T105

024240105

~~€ 250,00~~ € 99

Set chei tubulare 3/4"

3/4"



928A 22-24-27-30-32-34-36-38-41-46-50 mm



T63

024240063

~~€ 281,00~~ € 169

Set tubulare articulate



952 7-8-10-12-13-14-17-19 mm

867/C52

008670901

~~€ 112,00~~ € 59

Set imbusuri speciale



- 867PE 4-5-6-7-8-10-12 mm
- 867PE/L 4-5-6-7-8-10-12 mm
- 867XZN M5-M6-M8-M10-M12
- 867XZN/L M5-M6-M8-M10-M12
- 867TX T20-T25-T30-T40-T45-T50-T55
- 867TX/L T20-T25-T30-T40-T45-T50-T55
- 867RTX T20-T25-T30-T40-T45-T50-T55
- 867RTX/L T20-T25-T30-T40-T45-T50-T55
- 867/1 □ 10 mm - □ 3/8
- 867/2 □ 10 mm - □ 1/2



T264

024240264

~~€ 183,50~~ € 89

Set chei filtru și bușon ulei



- 1941 ∅ 65 - 110 mm
- 1494 ■ 10 mm
- 1494E ○ 8-9-10-11
- 12-14-17 mm
- 1494Q 8-9,5-12-13 mm
- 1494T 9,5
- 1494XZN 16
- 1496C ■ 8x ■ 10 mm



T110

024240110

~~€ 164,50~~ € 109

Set tubulare impact 1/2"



1/2"

- 720 10-11-12
- 13-14-16
- 17-18-19
- 21-22-23-24 mm
- 720/21 125 mm



T236

024240236

~~€ 78,00~~ € 49

Set pile



- 1719BMA/Q 200 mm
- ▲ 1719BMA/T 200 mm
- 1719BMA/P 200 mm
- ▶ 1719BMA/M 200 mm
- 1719BMA/R 200 mm



T46

024240046

Set chei combinate cu clichet rabatabil

142SN 8-9-10-11-12-13-14-15-16-17-18-19 mm

~~€ 308,00~~ € 209



C24S/7 - 230

Dulap mobil cu 7 sertare și 230 scule

- 7 sertare cu glisieră pe rulmenți.
- Baza sertarelor protejate cu covorașe din spumă de cauciuc.
- 4 roți cu Ø 125 mm: 2 fixe și 2 orientabile (cu o frână).
- Încădire centralizată frontală.
- Blat din material termoplastice foarte rezistent, destinat lăzilor de scule C22S, C23S, C23SC și C23ST
- Suport lateral pentru recipiente.
- Poate fi dotat cu suport rolă hârtie 2400S-R/PC.



~~€ 2.260~~ € 1.190



UZ GENERAL

Componentă 230 de scule în suport de burete

- set chei tubulare și accesorii 1/2" hexagonale 8-32 mm
- set chei tubulare lungi 1/2" hexagonale 10-22 mm
- set chei imbus 1/2" 5-14 mm
- set chei imbus TORX 1/2" T27-T60
- set chei tubulare și accesorii 3/8" hexagonale 6-22mm
- set chei tubulare lungi 3/8" hexagonale 8-19mm
- set chei imbus 3/8" 4-10mm
- set chei imbus TORX 3/8" T15-T45
- set chei tubulare 1/4" hexagonale 4-14 mm
- set chei tubulare lungi 1/4" hexagonale 4-14 mm
- set chei imbus 1/4" hexagonale 3-8 mm
- set chei imbus TORX 1/4" T06-T25
- daltă îngustă 125mm
- daltă lată 150mm
- punctator 4mm
- set șurubelniță și biți 4mm
- set chei combinate 6-32 mm
- set chei fixe 6x7-20x22 mm
- set chei inelare cotite 6x7-20x22 mm
- cheie reglabilă 250 mm
- set imbusuri hexagonale lungi 1,5-10 mm
- set șurubelnițe drepte
- set șurubelnițe Philips
- set șurubelnițe Torx
- clește autoblocant
- set patent, sfic și patent îngust
- set clești siguranțe interior, cu vârf drept și îndoit
- set clești siguranțe exterior, cu vârf drept și îndoit
- ciocan metalic
- ciocan plastic
- set biți și adaptor 1/4"



C24S/7 - 200



Dulap mobil cu 7 sertare și 200 scule

- 7 sertare cu glisieră pe rulmenți.
- Baza sertarelor protejate cu covorașe din spumă de cauciuc.
- 4 roți cu Ø 125 mm: 2 fixe și 2 orientabile (cu o frână).
- Închidere centralizată frontală.
- Blat din material termoplastice foarte rezistent, destinat lăzilor de scule C22S, C23S, C23SC și C23ST
- Suport lateral pentru recipiente.
- Poate fi dotat cu suport rolă hârtie 2400S-R/PC.

€ 2.549

€ 1.290



MECANICĂ AUTO

Componentă 200 de scule în suport termoformat

- set chei tubulare 1/2" hexagonale 10-32 mm
- cheie cu clichet 1/2"
- set prelungitoare 1/2", 125-250 mm
- bară forță, articulație cardanică 1/2"
- set chei tubulare 3/8", 6-22 mm
- cheie cu clichet 3/8"
- set prelungitoare 3/8", 125-250 mm
- bară forță, articulație cardanică 3/8"
- set chei tubulare 1/4" hexagonale 4-14 mm
- cheie clichet 1/4"
- set prelungitoare 1/4", 50-150 mm
- articulație cardanică 1/4"
- bară forță 1/4"
- set imbus 2,5-8 mm
- set imbusuri hexagonale 5-10 mm
- set chei combinate 6-32 mm
- set chei fixe 6x7-20x22 mm
- clește reglabil
- clește autoblocant
- set patent, sfic și patent îngust
- set clești siguranțe interior, cu vârf drept și îndoit
- set clești siguranțe exterior, cu vârf drept și îndoit
- ciocan metalic
- ciocan plastic
- set dălți 100-200 mm
- set imbusuri TORX, T20-T55 scurte și lungi
- set imbusuri XZN, M5-M12 scurte și lungi
- set imbusuri RTX, T20-T55 scurte și lungi
- set imbusuri HEX, 4-12 mm scurte și lungi
- adaptor 10 mm - 3/8"
- adaptor 10 mm - 1/2"
- set șurubelnițe drepte și Philips
- set imbusuri 1,5-10 mm
- set imbusuri "T" hexagonale 2-6 mm
- set imbusuri "T" torx T10-T30



C24S/7 - 260



Dulap mobil cu 7 sertare și 260 scule

€ 3.197,50 € 1.590

- 7 sertare cu glisiere pe rulmenți.
- Baza sertarelor protejate cu covorașe din spumă de cauciuc.
- 4 roți cu Ø 125 mm: 2 fixe și 2 orientabile (cu o frână).
- Închidere centralizată frontală.
- Blat din material termoplastic foarte rezistent, destinat lăzilor de scule C22S, C23S, C23SC și C23ST
- Suport lateral pentru recipiente.
- Poate fi dotat cu suport rolă hârtie 2400S-R/PC.



MECANICĂ AUTO

Componentă 260 de scule în suport termoformat

- set chei tubulare 1/2", 10-32 mm
- cheie cu clichet, cardan și bară forță 1/2"
- prelungitoare 1/2", 125 și 250 mm
- set chei tubulare 3/8", 6-22 mm
- prelungitoare 3/8", 125 și 250 mm
- cheie cu clichet, bară forță, articulație cardanică 3/8"
- set chei tubulare 1/4" hexagonale 4-14 mm
- cheie clichet, articulație cardanică, bară forță 1/4"
- prelungitoare 1/4", 50-150 mm
- set tubulare Torx, 1/4" și 1/2" E4-E10, E12-E24
- imbus Torx, 1/2", T60, T55 și T70, lung
- set imbusuri Torx, T6-T55
- set imbusuri hexagonale, 1/2", 5-10 mm
- set chei combinate 6-32 mm
- set chei inelare cotite 6x7-27x29 mm
- set chei fixe 6x7-20x22 mm
- clește reglabil și clește autoblocant
- set patent, sfic și patent îngust
- clești siguranțe int.-ext., cu vârf drept și îndoit
- ciocan metalic și ciocan plastic
- set dălți 100-200 mm
- set imbusuri TORX, T20-T55 scurte și lungi
- set imbusuri XZN, M5-M12 scurte și lungi
- set imbusuri RTX, T20-T55 scurte și lungi
- set imbusuri HEX, 4-12 mm scurte și lungi
- adaptor 10 mm - 3/8"
- adaptor 10 mm - 1/2"
- set șurubelnițe drepte și Philips
- set imbusuri 1,5-10 mm
- set imbusuri "T" hexagonale 2-6 mm
- set imbusuri "T" torx T10-T30
- set chei filtre și bușoane ulei



C24SA-XL/7 - 300



Dulap mobil cu 7 sertare, extra-lung și 300 scule

€ 3.896,50 € 1.890

- 7 sertare (882x367 mm) cu glisiere pe rulmenți.
- Blat din ABS solid, cu 6 locașuri.
- Parte frontală rezistentă, din plastic special,
- Baza sertarelor protejate cu covorașe din spumă de cauciuc.
- 4 roți cu Ø 125 mm: 2 fixe și 2 orientabile (cu o frână).
- Închidere centralizată frontală.
- Suport lateral pentru recipiente.



MECANICĂ AUTO

Componentă 300 de scule în suport termoformat

- set chei tubulare 1/2", 10-32 mm
- cheie cu clichet, cardan și bară forță 1/2"
- prelungitoare 1/2", 125 și 250 mm
- set chei tubulare 3/8", 6-22 mm
- prelungitoare 3/8", 125 și 250 mm
- cheie cu clichet, bară forță, articulație cardanică 3/8"
- set chei tubulare 1/4", hexagonale 4-14 mm
- cheie clichet, articulație cardanică, bară forță 1/4"
- prelungitoare 1/4", 50-150 mm
- set tubulare Torx, 1/4" și 1/2" E4-E10, E12-E24
- imbus Torx, 1/2", T60, T55 și T70, lung
- set imbusuri Torx, T6-T55
- set imbusuri hexagonale, 1/2", 5-10 mm
- set chei combinate 6-32 mm
- set chei inelare cotite 6x7- 27x29 mm
- set chei fixe 6x7-20x22 mm
- clește reglabil și clește autoblocant
- set patent, sfic și patent îngust
- clești siguranțe int.-ext., cu vârf drept și îndoit
- ciocan metalic și ciocan plastic
- set dălți 100-200 mm
- set imbusuri speciale HEX, TORX, RTX, XZN
- set șurubelnițe drepte și Philips
- set imbusuri 1,5-10 mm
- set imbusuri "T" hexagonale 2-6 mm
- set imbusuri "T" torx T10-T30
- set chei filtre și busoane ulei



2400S XL09/E-XL - 493



024002251

024002252

024002253

€ 4423 € 1990

Dulap mobil cu 9 sertare, extra-lung și 493 scule

- 9 sertare (882x367 mm) cu glisiere pe rulmenți.
- 8 sertare cu înălțimea de 70mm
1 sertar cu înălțimea de 140mm
- Blat din ABS solid, cu 6 locașuri .
- Parte frontală rezistentă, din plastic special
- Baza sertarelor protejate cu covorașe din spumă decauciuc.
- 4 roți cu Ø 125 mm: 2 fixe și 2 orientabile (cu o frână).
- Închidere centralizată frontală.
- Suport lateral pentru recipiente



2400S XLG9/E-XL

024002252

UZ GENERAL

970 mm
445 mm
1035 mm

n°	h	max
8	70 mm	30 kg
1	140 mm	35 kg

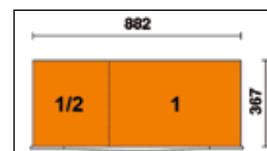

2400S XLR9/E-XL 2XLG-XL

024002253

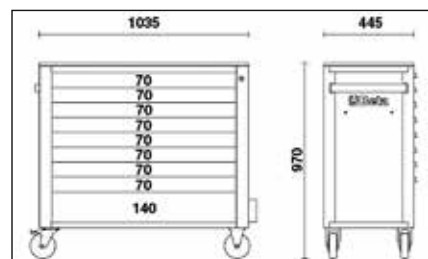

- 1/4"** C900 ○ 4-4,5-5-5,5-6-7-8-9-10-11-12-13-14 mm
 C900L ○ 4-4,5-5-5,5-6-7-8-9-10-11-12-13-14 mm
 C900FTX ○ E4-E5-E6-E7-E8-E10
 900E/55 Ⓞ
 C900/25
 C900/21 50 mm
 C900/20L 100 mm
 C900/30 150 mm
 C900/42 115 mm
 C900ME ○ 3-4-5-6-7-8 mm
 C900TX ○ T06-T07-T08-T09-T10-T15-T20-T25
 C900LP ● 0,8x4-1x5,5-1,2x6,5-1,2x8 mm
 C900PH ⊕ PH0-PH1-PH2-PH3
 C900AD Ⓢ 14"

- 3/8"** C910A ○ 6-7-8-9-10-11-12-13-14-15-16-17-18-19-20-21-22-24 mm
 C910L ○ 8-10-11-12-13-14-17-19 mm
 C910FTX ○ E6-E7-E8-E10-E11-E12-E14
 910E/55 200 mm
 C910/25
 C910/21 75 mm
 C910/22 150 mm
 C920/15F □ 1/2" - ■ 3/8"
 C910PE ○ 4-5-6-7-8-9-10 mm
 C910TX ⊕ T15-T20-T25-T27-T30-T40-T45
 860EA/31 ⊕ ⊕ ⊕ ⊕



1256/C36-2



- 1/2"** C920A ○ 8-9-10-11-12-13-14-15-16-17-18-19-20-21-22-23-24-27-30-32 mm
 C920L ○ 10-12-13-14-15-16-17-18-19-21-22-24-27-30-32 mm
 C920FTX ○ E10-E12-E14-E16-E18-E20-E22-E24
 920E/55 Ⓞ
 C920/25
 C920/21 125 mm
 C920/22 250 mm
 C910/16F □ 3/8" - ■ 1/2"
 C920PE ○ 5-6-7-8-9-10-12-14 mm
 C920PE/L ○ 5-6-7-8-9-10-12-14 mm
 C920TX ⊕ T27-T30-T40-T45-T50-T55-T60
 C920TX/L ⊕ T30-T40-T45-T50-T55-T60-T70



55 6x7-8x9-10x11-12x13-14x15-16x17-18x19-20x22-21x23-24x27-30x32 mm
 90 6x7-8x9-10x11-12x13-14x15-16x17-18x19-20x22-21x23-24x27-30x32 mm
 97BTX/SC8 T9-T10-T15-T20-T25-T27-T30-T40



1201 2,5x50-3x75-4x100-5,5x125-6,5x150- 8x200 mm
 1201N 4x30 mm
 1202 PH0x60-PH1x80-PH2x100-PH3x150
 1202N PH1x30 mm
 1207TX T06-T07-T08-T09- T10-T15-T20-T25-T27-T30-T40-T45
 1253 3,5x100 mm



42C 6-7-8-9-10-11-12-13-14-15-16-17-18-19- 20-21- 22-23-24-27-30-32 mm
 96BPC/SC9 1,5-2-2,5-3-4-5-6-8-10 mm



1370 500 g
 1380 1000 g
 1390 Ø 35 mm
 1737NX



142 8-9-10-11-12-13-14-15-16-17-18-19 mm
 410/SP19 Ø 1+10 x 0,5 mm
 1725CR 250 mm



1082CM 160 mm
 1150CM 180 mm
 1166CM 200 mm
 1168CM 200 mm
 1048 250 mm
 1098 220 mm
 1032-180 19+60 mm
 1034-170 19+60 mm
 1036-175 19+60 mm
 1038-175 19+60 mm
 1052 190-240 mm
 1128BMX



1149F 1716P
 1602 1716U
 1603 1716A
 1716R



97TTX T8-T9-T10-T15-T20-T25-T27-T30-T40
 1650 150 mm
 1682 300 mm



30 Ø 2-3-4 mm
 31 Ø 2-3-4-5-6-8 mm
 32 Ø 4 mm
 34 125-150-175 mm
 36 125 mm
 1692 3 m
 1712TF
 1719BMA/Q 200 mm
 1719BMA/T 200 mm
 1719BMA/P 200 mm
 1719BMA/M 200 mm
 1719BMA/R 200 mm
 1725 420 mm
 1771
 1835/2



123E1/4
 123Q1/4
 123Q3/8
 123Q1/2
 720 12-13-15-17-19-21-24 mm
 720LC 17-19-21-24 mm
 720/21 125 mm
 900/16
 910/15
 910/16
 920/15
 920/16
 943FL 6-7-8
 1687D 153 mm
 1687U 153 mm
 1687A 153 mm
 1687AC 153 mm



943E 6-7-8-9-10-11-12-13 mm



96T 2-2,5-3-4-5-6-7-8 mm



C24S/7 - 180

Dulap mobil cu 7 sertare și 180 scule pentru autocamioane

€ 2.999,50 € 1.590

- 7 sertare cu glisiere pe rulmenți.
- Baza sertarelor protejate cu covorașe din spumă de cauciuc.
- 4 roți cu Ø 125 mm: 2 fixe și 2 orientabile (cu o frână).
- Închidere centralizată frontală.
- Blat din material termoplastic foarte rezistent, destinat lăzilor de scule C22S, C23S, C23SC și C23ST
- Suport lateral pentru recipiente.
- Poate fi dotat cu suport rolă hârtie 2400S-R/PC.



AUTOCAMIOANE

Componentă 180 de scule în suport termoformat

- set chei tubulare 1/2", 10-32 mm
- cheie cu clichet 1/2"
- set capete tip imbus 5-6-8-10 mm
- prelungitoare 1/2", 250 mm și 125mm
- articulație cardanică 1/2"
- bara de forță și cap culisant 1/2"
- set chei tubulare 3/4" hexagonale 22-50 mm
- cheie cu clichet 3/4"
- prelungitor 3/4", 200 și 380 mm
- bară de forță 3/4"
- chei inelare cotite 6x7-34x36 mm
- chei combinate 6-32 mm
- chei fixe 6x7-20x22 mm
- set imbusuri hexagonale 1.5 – 10 mm
- set imbusuri hexagonale cu mâner 2 – 6 mm
- set imbusuri Torx cu mâner T10 – T30
- clește de siguranțe drept, de interior și exterior
- clește de siguranțe îndoite, de interior și exterior
- clește reglabil 240 mm
- clește autoblocant 240 mm
- set imbusuri TORX, T20-T55 scurte și lungi
- set imbusuri XZN, M5-M12 scurte și lungi
- set imbusuri RTX, T20-T55 scurte și lungi
- set imbusuri HEX, 4-12 mm scurte și lungi
- adaptor 10 mm - 3/8" și 1/2"
- patent, sfic și patent îngust
- dălți 100-200 mm
- set șurubelnițe drepte și Philips
- ciocan metalic cu mâner de lemn 300 g
- ciocan metalic 1500 g
- ciocan plastic cu capete interschimbabile



C24S/7 - 220



Dulap mobil cu 7 sertare și 220 scule pentru tinichigerie

~~€ 2.640~~ € 1.390

- 7 sertare cu glisieră pe rulmenți.
- Baza sertarelor protejate cu covorașe din spumă de cauciuc.
- 4 roți cu Ø 125 mm: 2 fixe și 2 orientabile (cu o frână).
- Închidere centralizată frontală.
- Blat din material termoplastice foarte rezistent, destinat lăzilor de scule C22S, C23S, C23SC și C23ST
- Suport lateral pentru recipiente.
- Poate fi dotat cu suport rolă hârtie 2400S-R/PC.



TINICHIGERIE

Componentă 220 de scule în suport de burete

- set chei tubulare 1/2" hexagonale 8-32 mm
- set chei tubulare lungi 1/2" hexagonale 10-22 mm
- set chei imbus 1/2" hexagonale 5-14 mm
- set chei imbus 1/2" torx T27-T60
- cheie cu clichet 1/2"
- set prelungitoare 1/2", 125-250 mm
- bară forță, articulație cardanică 1/2"
- set chei tubulare 1/4" hexagonale 4-14 mm
- set chei tubulare lungi 1/4" hexagonale 4-14 mm
- set chei imbus 1/4" hexagonale 3-8 mm
- set chei imbus 1/4" torx T06-T25
- cheie clichet 1/4"
- set prelungitoare 1/4", 50-150 mm
- articulație cardanică 1/4"
- bară forță 1/4"
- set chei combinate 6-24 mm
- set chei fixe 6x7-20x22 mm
- set chei inelare cotite 6x7-20x22 mm
- cheie reglabila 250 mm
- set imbusuri hexagonale 1,5-10 mm
- set șurubelnițe drepte
- set șurubelnițe Philips
- set șurubelnițe Torx
- clește autoblocant
- set patent, sfc și patent îngust
- set clești siguranțe interior, cu vârf drept și îndoit
- set clești siguranțe exterior, cu vârf drept și îndoit
- ciocan metalic
- ciocan plastic
- set dălți 100-200 mm
- set 6 corpuri diverse tinichigerie
- set 3 ciocane tinichigerie
- lingură tinichigerie
- pilă tinichigerie



C5

02105000

Rucsac de scule din țesătură tehnică

- Panou interior detasabil
- 6 buzunare exterioare
- 2 buzunare interioare
- Baza impermeabilă din plastic
- Spate căptusit ergonomic

500x400x180 mm

~~€ 125~~

€ 79



C5S- reper nou

021050100

Rucsac de scule din poliester rezistent

- Mâner dublu în partea superioară a rucsacului
- Două buzunare frontale mari
- Două buzunare interioare mari
- 2 curele Velcro pentru scule
- Geantă de rulare la îndemână, compusă din 4 panouri de scule
- Curele de umăr reglabile

370x300x100 mm

~~€ 45~~

€ 29



2 buzunare mari frontale



CP17

Cutie de scule, din inox și plastic
cu tavă de scule detașabilă



	KG		
CP17	2,5	021170500	€ 70 €44
CP17L	3,7	021170502	€ 101 €69



CP15

Cutie de scule, din plastic

- o tavă de scule detașabilă de dimensiunea cutiei
- 2 cutii pentru piese mici, detașabile
cu despărțituri reglabile
- capacitate portantă 30kg

 021150201

~~€ 38~~ € 25



 445x240x250 mm

C20L

Cutie de scule cu 5 secțiuni rabatabile,
confectionată din tablă

 021200002

~~€ 67,50~~ € 46



 550x200x210 mm



COMBO

CEL MAI NOU SISTEM MODULAR BETA

Combo este noul sistem modular Beta alcătuit din 3 tipuri diferite de cutii de scule robuste. Cutiile pentru scule pot fi ușor unite între ele printr-un simplu clic, prin mecanismul lateral inovativ.



3 tipuri diferite de cutii robuste

C99 reper nou

BETA COMBO sistem modular

Compus din:

- Cărucior pliant din aluminiu ultracomact C99P (485x520x1195 mm)
- Cutie de scule ABS C99V1 (445x358x152 mm)
- Cutie de scule ABS C99V2 (445x358x254 mm)
- Cutie de scule ABS cu 2 tăvi portabile C99V3 / 2C (445x358x322 mm)

099000010

~~€ 557~~

€ 384



C99V1

099000250

Cutie pentru scule din ABS

- Dimensiuni exterioare: 445x358x152 mm
- Capacitate încărcare maximă: 25 kg
- Greutate: 2,2 kg
- Sistem de autofixare

kg 25

~~€ 94~~ € 65

445x358x152 mm



kg 2,2

C99V2

099000350

Cutie pentru scule din ABS

- Dimensiuni : 445x358x254 mm
- Capacitate încărcare maximă: 25 kg
- Sistem de autofixare

kg 25

~~€ 104~~ € 72

445x358x254 mm



kg 2,8

C99V3/2C

099000450

Cutie pentru scule, din ABS, cu 2 tăvi portabile

- Dimensiuni exterioare: 445x358x322 mm
- Capacitate încărcare maximă: 25 kg
- Echipată cu 2 tăvi compartimentate C99C-V3

kg 25

~~€ 200~~ € 138



445x358x322 mm

kg 5,6

C99P

099000101

Căruțior pliant din aluminiu ultracompact

- Mâner telescopic
- Dimensiuni la deschidere: 485x520x1195 mm
- Dimensiuni la închidere: 485x60x905 mm
- Dimensiunile bazei rabatabile: 485x350 mm
- Două roți rezistente la perforare, Ø 175 mm
- Livrat cu curea

~~€ 159~~ € 110



kg 120

kg 5,1

1195 mm
485 mm
905 mm

Noul sistem, Beta Combo C99, este compatibil cu standardul L-BOXX Sortimo®.

C99TP-V3

099000480

Set de tăvi termoformate cu 7 compartimente și set de 17 cutii

~~€ 42~~ € 29

- 1 tavă termoformată cu 7 compartimente pentru cutia de scule C99T-V3
- 1 kit de 17 cutii pentru cutia de scule C99P-V3 compus din :
 - 6 cutii roșii 52x52 mm
 - 2 cutii galbene 104x52 mm
 - 3 cutii gri 78x260 mm și 6 pereți despărțitori



C99C-V3



C99PC/T

099000490

Suport termoformat pentru cutii de scule C99V1 - C99V3 / 2C

~~€ 37~~ € 26

- 1 tavă termoformată, 4 compartimente C99T, capac burete



C99M

099000494

Insert din spumă moale pentru cutiile de scule C99V, C99V2 și C99V3 / 2C

~~€ 38~~ € 26

- Material ce permite amplasarea în siguranță a oricărei scule în interiorul cutiei



2056E

1/4" **1/2"**

020560010

Trusă cu 163 de scule pentru întreținere și reparații

- panouri interschimbabile
- suport din spumă de cauciuc pentru scule

~~€ 740~~

€ 389

163



450x330x142 mm



860EA/31

- 861LP 0,5x3-0,6x4,5-0,8x5,5-1,0x5,5-1,2x6,5-1,6x8 mm
- 861PH 1-2-3
- 861PZ 1-2-3
- 861PE 2-3-4-5-6-8 mm
- 861TX T8-T9-T10-T15-T20-T25-T27-T30-T40
- 861PQ 1-2-3 mm
- 882M1 1/4 - 1/4

1/4"

	42C	8-9-10-11-12-13-14-15-16-17-18-19 mm
	96 BPC/SC9	1,5-2-2,5-3-4-5-6-8-10 mm
	895 /1	1/4 - 1/4
	C900	4-4,5-5-5,5-6-7-8-9-10-11-12-13-14 mm
	C900/20	50 mm
	C900/20L	100 mm
	C900/25	
	C900/30	150 mm
	C900/42	110 mm
	900E/55	

1/2"

	C920A	10-11-12-13-14-15-16-17-18-19-21-22-24 mm
	C920/21	125 mm
	C920/25	
	C920/42	250 mm
	920E/55	

	1256TX	T3-T4-T5-T6-T7-T8-T9-T10-T15
	1256RTX	T6-T7-T8-T9-T10
	1256LP	0,8-1,2-1,5-1,8-2,2-2,5-3-3,5-4 mm
	1256PE	0,7-0,9-1,3-1,5-2 mm
	1256PH	PH000-PH00-PH0-PH1
	1256PZ	PZ000-PZ00-PZ0-PZ1
	1256/20	
	1256/30	4 mm 110 mm



	111	250 mm
	1048	250 mm
	1082CM	160 mm
	1098	220 mm
	1150CM	180 mm
	1166CM	160 mm
	1128BMX	
	1201	3x75-4x125-5,5x150-6,5x150 mm
	1202	PH1x80 - PH2x100 mm
	1253	3,5x100 mm
	1370	300 g
	1692/5	5 m
	1725CR	150 mm
	1771	3x 18 mm

2047E/C108-21

1/4" **1/2"**

020470008

Trusă de scule pentru întreținere și reparații

~~€ 492~~

€ 239

108



555x370x92 mm



1/4"

	C900	○	4-4,5-5-5,5-6-7-8-9-10-11-12-13-14 mm
	900E/55	⊕	
	C900/25		
	C900/20		50 mm
	C900/20L		100 mm
	C900/30		150 mm
	C900/42		115 mm



860EA/31

- 861LP 0,5x3-0,6x4-5-0,8x5,5-1,0x5,5-1,2x6,5-1,6x8 mm
- 861PH 1-2-3
- 861PZ 1-2-3
- 861PE 2-3-4-5-6-8 mm
- 861TX T8-T9-T10-T15-T20-T25-T27-T30-T40
- 861PQ 1-2-3 mm
- 862M1 ○ 1/4 • 1/4

1/2"

	C920A	○	10-11-12-13-14-15-16-17-18-19-20-21-22-24-27-30-32 mm
	C956C	○	16 mm (5/8") - 21 mm (13/16")
	920E/55	⊕	
	C920/25		
	C920/21		125 mm
	C920/22		250 mm
	C910/16F		□ 3/8" - ■ 1/2"

	C900AD		
	42C		7-8-9-10-11-12-13-14 15-16-17-18-19 mm
	96/SC9	○	1,5-2-2,5-3-4-5-6-8-10 mm
	1048		250 mm
	1082CM	⌞	160 mm
	1150CM	≡	180 mm
	1166CM	●	160 mm
	1201	●	3x75-4x100-5,5x125 6,5x150mm
	1202	⊕	PH1-PH2
	1370		300 g

903E/C42

14"

009031042

Set chei tubulare și accesorii 1/4"

~~€ 110~~

€ 49



	C900	○	4-4,5-5-5,5-6-7-8-9-10-11-12-13-14 mm
	900E/55	⊗	
	C900/25		
	C900/20		50 mm
	C900/20L		100 mm
	C900/42		115 mm
	C900/30		150 mm
	96	○	1,3-1,5-2-2,5 mm
	C900AD	⊗ 14"	
	861LP	●	⊗ 0,6x4-0,8x5,5-1,2x6,5 mm
	861PH	⊕	⊗ PH1-PH2-PH3
	861PZ	⊕	⊗ PZ1-PZ2-PZ3
	861PE	○	⊗ 3-4-5-6 mm
	861TX	⊗	⊗ T10-T15-T20-T25-T30



≡ 190x160x60 mm

913E/C33

3/8"

009131033

Set chei tubulare și accesorii 3/8"

~~€ 131~~

€ 59



	C910A	○	6-7-8-9-10-11-12-13-14-15-16-17-18-19-20-21-22-24 mm
	C910AL	○	8-9-10-12-13-14-17-19 mm
	C956E	○	16 mm (5/8") 21 mm (13/16")
	910E/55	⊗	
	C910/25		
	C910/21		75 mm
	C910/22		150 mm
	C920/15F	□	□ 1/2" - ■ 3/8"



≡ 285x210x84 mm

923E/C25

1 1/2"







009231025

Set chei tubulare și accesorii 1/2"

~~€ 166~~

€ 69

25

	C920A	○	8-9-10-11-12-13-14-15-16-17-18-19-20-21-22-23-24-27-30-32 mm
	920E/55	⊗	
	C920/25		
	C920/21		125 mm
	C920/22		250 mm
	C910/16F	□ 3/8" - ■ 1/2"	



285x210x84 mm

928E/C17

009282017

Set chei tubulare și accesorii 3/4"

~~€ 402~~

€ 199

17

3/4"

	C928A	○	22-24-27-30-32-34-36-38-41-46-50-55 mm
	C928/55	⊗	
	C928/25		
	C928/21		100 mm
	C928/22		200 mm
	C928/42		455 mm



555x370x92 mm

903E/C98

14" **12"**

009031098

Set chei tubulare și accesorii 1/4" și 1/2"

~~€ 242~~

€ 119



1/4"

	C900	○	4-4,5-5-5,5-6-7-8-9-10-11-12-13-14 mm
	C900L	○	6-7-8-9-10-11-12-13 mm
	900E/55	⊕	
	C900/25		
	C900/20		50 mm
	C900/20L		100 mm
	C900/30		150 mm
	C900/42		115 mm



≡ 375x295x84 mm

1/2"

	C920A	○	10-11-12-13-14-15-16-17-18-19-20-21-22-24-27-30-32 mm
	C920L	○	14-15-17-19-22 mm
	C956C	○	16 mm (5/8") - 21 mm (13/16")
	920E/55	⊕	
	C920/25		
	C920/21		125 mm
	C920/22		250 mm

	C910/16F	□ 3/8" - ■ 1/2"
	C895/6	□ 1/2" - ○ 5/16"
	C900AD	⊕ 1/4"
	892/0	● 1/4" - ■ 1/4"
	861PH	⊕ ⊕ PH1-PH2
	861PZ	⊕ ⊕ PZ1-PZ2
	861PE	○ ⊕ 3-4-5-6 mm
	861LP	● ⊕ 0,6x4-0,8x5,5-1,2x6,5 mm
	861TX	⊕ ⊕ T10-T15-T20-T25-T27-T30
	C866LP	● ⊕ 1,6x8-1,6x10-2,0x12 mm
	C866PH	⊕ ⊕ PH3-PH4
	C866PZ	⊕ ⊕ PZ3-PZ4
	866PE	○ ⊕ 7-8-10-12-14 mm
	866TX	⊕ ⊕ T40-T45-T50-T55-T60-T70
	96	○ 1,3-1,5-2-2,5 mm

903E/C170

1/4" 3/8" 1/2"

009031170

Set chei tubulare și accesorii 1/4", 3/8" și 1/2"

~~€ 445~~

€ 209



1/4"

	C900	○	4-4,5-5-5,5-6-7-8-9-10-11-12-13-14 mm
	C900L	○	4-5-6-7-8-9-10 mm
	900E/55	⊗	
	C900/25		
	C900/20		50 mm
	C900/20L		100 mm
	C900/30		150 mm
	C900/42		115 mm
	C900FTX	⊗	E4-E5-E6-E7-E8
	C900LP	●	0,8x4-1,0x5,5-1,2x6,5-1,2x8 mm
	C900PH	⊕	PH0-PH1-PH2
	C900PZ	⊕	PZ0-PZ1-PZ2
	C900ME	○	3-4-5-6 mm
	C900TX	⊗	T08-T09-T10-T15-T20-T25-T27-T30
	C900RTX	⊗	T08-T09-T10-T15-T20-T25-T27-T30

3/8"

	C910A	○	10-11-12-13-14-15-16-17-18-19 mm
	C910AL	○	10-11-12-13-14-15 mm
	C910FTX	⊗	E10-E11-E12-E14-E16
	C956E	○	18 mm (11/16")
	910E/55	⊗	
	C910/25		
	C910/22		150 mm

1/2"

	C920A	○	10-11-12-13-14-15-16-17-18-19-20-21-22-24-27-30-32 mm
	C920L	○	16-17-18-19-22 mm
	C920FTX	⊗	E18-E20-E24
	C956C	○	16 mm (5/8") - 21 mm (13/16")
	920E/55	⊗	
	C920/25		
	C920/21		125 mm
	C920/22		250 mm
	C910/16F	□ 3/8" - ■ 1/2"	



453x375x90 mm

	96	○	0,9-1,5-2-2,5-3-4-5 mm
	C895/4	□ 3/8" - ◇ 5/16"	
	C895/6	□ 1/2" - ◇ 5/16"	
	C900AD	⊗ - 1/4"	
	892/0	⊗ - 1/4"	
	861RTX	⊗	T09-T10-T15-T20-T25-T27-T30-T40
	861TX	⊗	T6-T7-T8
	861RIBE	⊗	7-8-9 mm
	861XZN	○	5-6-8 mm
	C866LP	●	1,6x8-1,6x10-2,0x12 mm
	C866PH	⊕	PH3-PH4
	C866PZ	⊕	PZ3-PZ4
	866PE	○	7-8-10-12-14 mm
	866TX	⊗	T40-T45-T50-T55-T60-T70
	866RTX	⊗	T40-T45-T50-T55-T60-T70

97TTX/S6



Set imbusuri Torx, tip T, cu mâner, 6 piese

○ T10-T15-T20-T25-T30-T40



000970791

~~€ 75,5~~ € 49

96T/S5P



Set imbusuri, tip T, cu mâner, 5 piese

○ 2,5-3-4-5-6 mm



000960946

~~€ 53~~ € 36

96BPC/SC9



Set imbusuri cu cap sferic, lungi, 9 piese, în suport

○ 1,5-2-2,5-3-4-5-6-8-10 mm

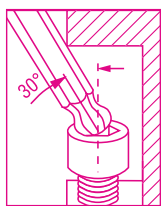

sistem de blocare a suportului



000960354

~~€ 36,5~~ € 25

951/S6



Set imbusuri cu mâner culisant, 6 piese

○ 2,5-3-4-5-6-8 mm



2,5÷6 mm



009510687

~~€ 107~~ € 74

42/SP15

000421078

Set chei combinate, 15 piese
în suport

6-7-8-9-10-11-12-13-14-15
16-17-19-22-24 mm



~~€ 151~~

€ 99



55/SP7

000550167

Set chei fixe, 7 piese ,
în suport

6x7-8x9-10x11-12x13-14x15
16x17-18x19 mm



~~€ 43,5~~

€ 30



142/SC9I

Set chei combinate cu clichet,
9 piese, în suport compact

8-10-11-12-13-14-15-17-19 mm



001420087

~~€ 183~~

€ 119

142SN/SC9

Set chei combinate cu
clichet articulat, 9 piese,
în suport compact

8-10-11-12-13-14-15-17-19 mm



001420259

~~€ 220~~

€ 139

1169BM/D3

011690133

Set clești, 3 piese, compus din patent, sfic, șpiț

~~€ 80~~ € 55

1082BM 160 mm



1150BM 180 mm

1166BM 160 mm



1169GBM/D3 - reper nou

011690273

Set clești, 3 piese, compus din patent, sfic, șpiț, finisare industrială

~~€ 71,50~~ € 49

1082GBM 160 mm



1150GBM 160 mm



1166GBM 160 mm



1169/D4

011690014

Set patent, sfic, șpiț, papagal

~~€ 94~~ € 65

1150 180 mm



1150 180 mm



1166 160 mm



1048 250 mm



1150HPC 180

011500618

Clește combinat heavy-duty cu muchii tăietoare integrate, din oțel sinterizat și mâner bi-material

~~€ 49,50~~ € 33

- duritatea muchiilor tăietoare: 65 HRC
- articulație poziționată asimetric, pentru îmbunătățirea efectului pârghiei
- durata medie de viață a muchiilor tăietoare mai mare cu 127%



1031/S4

010310000

Set clești pentru siguranțe elastice, 4 piese

~~€ 91,50~~ € 59

1036 175 mm
● 19 ÷ 60 mm



1032 180 mm
○ 19 ÷ 60 mm



1034 170 mm
○ 19 ÷ 60 mm



1038 175 mm
● 19 ÷ 60 mm



186 8-32

001860008

Cheie reglabilă cu prindere automată pentru piulițe hexagonale, de la 8 la 32mm
Ideală pentru piulițe hexagonale, Spline și capete Torx®, inclusiv pentru capete de șuruburi deteriorate

~~€ 42~~

€ 29

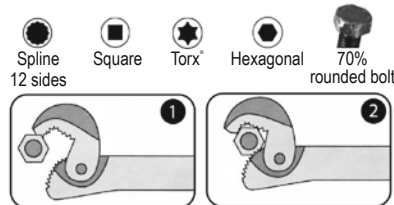

1009L/DP-S2

010090060

Set clești extralunghi, cu dublă articulație, cu cioc drept și îndoit

~~€ 63~~

€ 44



L 340 mm



1048 250

010480015

Clește reglabil, cu mâner

~~€ 30~~

€ 20



L 250 mm ø Max 50 mm Max 48 mm

9 poziții de reglare

Beta **evor**



- secțiunea octogonală previne rostogolirea accidentală pe suprafața de lucru
- mânerul perforat permite depozitarea șurubelniței prin agățare
- noul material din cauciuc termoplastic face utilizarea mai confortabilă
- tipul și dimensiunea vârfului sunt inscripționate pe extremitatea mânerului

Set șurubelnițe, 8 piese

1203E/D8P

012031018

~~€ 35,50~~

€ 24



- 1201 ● 2,5x50-3x75-4x100
5,5x100-6,5x150 mm
- 1202 ⊕ PH0x60-PH1x80
PH2x100 mm

Set șurubelnițe, 10 piese

1203E/D10N

012031019

~~€ 45,50~~

€ 29



Set șurubelnițe Torx, 7 piese

1207E/TX-D7

012071207

~~€ 46~~

€ 30



- 1201 ● 2,5x50-3x75-4x100
5,5x150-6,5x150 mm
- 1202 ⊕ PH0x60-PH1x80
PH2x100 mm
- 1201N ● 4x30 mm
- 1202N ⊕ PH1x30 mm

1207TX ⊕ T6-T8-T10-T15-T20-T25-T30



Set șurubelnițe, 8 piese

1263/D8

012630008

~~€ 48,50~~

€ 33



- 1260 ● 2,5x50-3x75-4x100
5,5x125-6,5x150 mm
- 1262 ⊕ PH0x60-PH1x80
PH2x100 mm

Set șurubelnițe, 10 piese

1263/D10

012630010

~~€ 62,00~~

€ 42



Set șurubelnițe Torx, 7 piese

1267TX/D7

012670307

~~€ 61,00~~

€ 42



1267TX ⊕ T6-T8-T10-T15-T20-T25-T30



- 1260 ● 3x75-3,5x100-4x125
5,5x150-6,5x150 mm
- 1262 ⊕ PH0x60- PH1x80
PH2x100 mm
- 1260N ● 4x30 mm
- 1262N ⊕ PH1x30 mm



Beta **GRIP**

1293/D8



012930403

Set șurubelnițe, 8 piese

- 1291 ● 3x75-4x100-5,5x100
6,5x150-8x150 mm
- 1292 ⊕ PH0x60-PH1x80-PH2x100 mm

Betamax
MAXIMUM PERFORMANCE

~~€ 66,50~~

€ 45



1243/D7



Set șurubelnițe de bătaie, 7 piese

1241 ⬤ 5,5x100-6,5x125-8x150-10x200 mm
1242 ⬤ PH1x100-PH2x100-PH3x150 mm

012430017

~~€ 82,50~~

€ 55



32AU

000320160

Punctator automat

~~€ 46~~

€ 29



L 150 mm

1370T

Ciocan de fier, cu mâner de fibră



	g		€	
1370T/200	200	013700620	€ 17,20	€ 12
1370T/300	300	013700630	€ 18,80	€ 13
1370T/500	500	013700650	€ 20,40	€ 14
1370T/800	800	013700680	€ 21,90	€ 15
1370T/1000	1000	013700700	€ 28,00	€ 19
1370T/1500	1500	013700750	€ 32,50	€ 22

1390

Ciocan cu capete de plastic, interschimbabile



	Ø mm		€	
1390/22	22	013900022	€ 15,50	€ 10
1390/28	28	013900028	€ 19,20	€ 13
1390/35	35	013900035	€ 26,00	€ 17
1390/45	45	013900045	€ 41,50	€ 29
1390/60	60	013900060	€ 71,00	€ 49

1719BMA8/B5

017190297

Set pile pentru metal, 5 piese

~~€ 69~~

€ 48



412M/SP19

004120469

~~€ 66,50~~ € 44

Set burghie cu tijă cilindrică,
19 piese, HSS, AISI M2,

Ø 1÷10 x 0,5 mm
115x170x40 mm



415C0/SP19

004150421

~~€ 80~~ € 56

Set burghie cu tijă cilindrică, 19
piese, HSS-Co 5%

Ø 1÷10 x 0,5 mm
115x170x40 mm



412/SP25P

004120415

~~€ 104,50~~ € 69

Set burghie cu tijă cilindrică,
25 piese, HSS

Ø 1÷10 x 0,5 mm
115x170x40 mm



426HS/SP10

004260210

~~€ 259~~ € 177

Set de 10 freze rotative
din HSS, cu tijă
cilindrică de 6 mm

110x150x40 mm



446/C110

004460060

Set filiere și tarozi cu accesorii,
pentru filete metrice, 110 piese,
în cutie de lemn

~~€ 725~~ € 490

III	III	III	III
430 M mm	433 M mm	440/440A M mm	441/441A M mm
2x0,4	6x0,75 - 7x0,75	2x0,4	6x0,75 - 7x0,75
3x0,5	8x0,75 - 8x1	3x0,5	8x0,75 - 8x1
4x0,7	9x0,75 - 9x1	4x0,7	9x0,75 - 9x1
5x0,8	10x0,75 - 10x1	5x0,8	10x0,75 - 10x1
6x1	10x1,25 - 11x0,75	6x1	10x1,25 - 11x0,75
7x1	11x1 - 11x1,25	7x1	11x1 - 11x1,25
8x1,25	12x0,75 - 12x1	8x1,25	12x0,75 - 12x1
9x1,25	12x1,25 - 12x1,5	9x1,25	12x1,25 - 12x1,5
10x1,5	14x1 - 14x1,25	10x1,5	14x1 - 14x1,25
11x1,5	14x1,5 - 16x1	11x1,5	14x1,5 - 16x1
12x1,75	16x1,5 - 18x1,5	12x1,75	16x1,5 - 18x1,5
14x2		14x2	
16x2		16x2	

435/0 444/1 436/1
435/3 444/2



500x337x60 mm

920/55L

12"

009200927

Cheie cu clichet extensibilă
• acționare 1/2"

~~€ 91,00~~

€ 61

7 trepte de lungime
280 - 422 mm

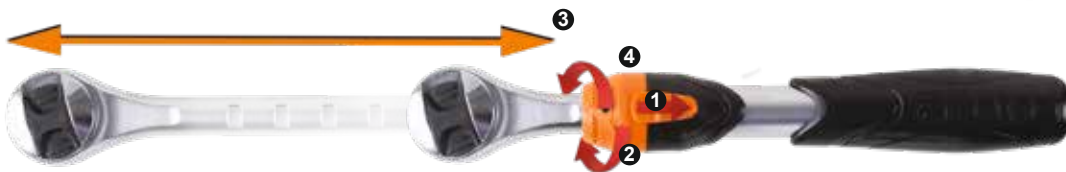

900/55Z

14"

009000882

Cheie cu clichet reversibil, 72 dinți
• acționare 1/4"

~~€ 39,50~~

€ 27

15 dinți
permanent
în contact
cu corpul
clichetului

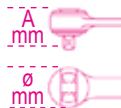

L mm	Ø mm	A mm	■
126	25	23	1/4



3/8"

12"

Cheie cu clichet reversibil, 72 dinți
• acționare 1/4"



	L mm	Ø mm	A mm	■	g			
910/55	200	30	33	3/8"	239	009100882	€ 43	€ 29
920/55	275	40	43	1/2"	475	009200882	€ 52	€ 36

14"

3/8"

12"

Cheie cu clichet reversibil

• dantură de acționare exterioară din oțel
• corp turnat din oțel rezistent

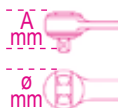

	L mm	Ø mm	A mm	■			
900M/55	110	22	18	1/4"	009000905	€ 50,50	€ 35
910M/55	178	30	26	3/8"	009100875	€ 59,00	€ 39
920M/55	253	38	35	1/2"	009200893	€ 67,50	€ 46

605E 1/4"

Cheie dinamometrică cu clichet reversibil

- acționare 1/4"
- clasă de precizie: $\pm 6\%$



UNI EN 26789 ISO 6789



	Nm	kgfm	lbf.ft	■	L (mm)	g			
605E/5	1÷5	0,1÷0,5	10÷45	1/4"	190	180	006050105	€ 179	€ 109
605E/10	2÷10	0,2÷1,0	18÷90	1/4"	190	180	006050110	€ 187	€ 119

666N 3/8" 12"

Cheie dinamometrică cu clichet reversibil

- clasă de precizie: $\pm 3\%$



UNI EN 26789 ISO 6789



	Nm	kgfm	lbf.ft	■	L (mm)	g			
666N/5	10÷50	1÷5	7÷37	3/8"	312	660	006660005	€ 198	€ 119
666N/10X	20÷100	2÷10	15÷75	1/2"	387	800	006660011	€ 204	€ 119
666N/20	40÷200	4÷20	30÷150	1/2"	470	1010	006660020	€ 217	€ 129
666N/30	60÷300	6÷30	50÷220	1/2"	598	1380	006660030	€ 247	€ 139

677 3/4"

Cheie dinamometrică cu clichet reversibil

- acționare 3/4"
- clasă de precizie: $\pm 4\%$



	Nm	kgfm	lbf.ft	■	L (mm)	kg			
677/100	300÷1000	30÷100	200÷750	3/4"	1470	7,5	006770100	€ 727	€ 459

665



Cheie dinamometrică cu clichet reversibil

- clasă de precizie: $\pm 3\%$
- afișaj digital

UNI EN 26789 ISO 6789



Reglare rapidă și precisă a cuplului digital

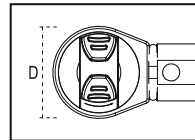
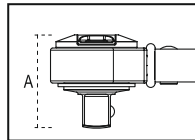

	Nm mm	■	D (mm)	A (mm)	L (mm)	g			
665/6	10÷60	3/8	30	33	335	655	006650006	€ 198,00	€ 129
665/10	20÷100	3/8	30	33	375	725	006650010	€ 199,50	€ 129
665/10X	20÷100	1/2	30	37	375	725	006650011	€ 204,00	€ 139
665/20	40÷200	1/2	40	43	470	995	006650020	€ 217,00	€ 149
665/30	60÷330	1/2	40	43	590	1260	006650030	€ 247,00	€ 169

610/5 - reper nou



006100025

Cheie dinamometrică cu clichet reversibil, dedicată pentru service roți

~~€ 149,00~~ € 99

- acționare 1/2"
- clasă de precizie: $\pm 4\%$
- 5 valori presetate 90 - 100 - 110 - 120 - 130Nm



610L/5 - reper nou



006100125

Bară dinamometrică de strângere, dedicată pentru service roți

~~€ 132~~ € 89

- acționare 1/2"
- clasa de precizie: $\pm 4\%$
- 5 valori presetate 90 - 100 - 110 - 120 - 130Nm

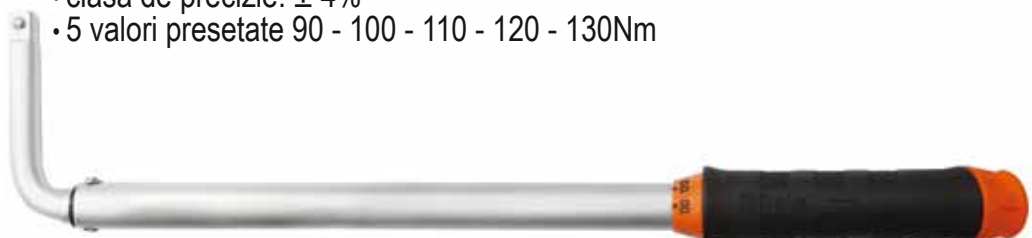

1651DGT/150

016510111

~~€ 107~~ € 74

A Max 150 mm
L 225 mm



Șubler digital, fabricat din oțel
în cutie de plastic
• Diviziune 0.01 mm
• Șurub de culisare
• Conversie Mm/inch

1651DGT/200

016510112

~~€ 126~~ € 87,50

A Max 200 mm
L 285 mm



DIN 862 UNI EN ISO 13385-1

1658/...

Micrometru de exterior
• diviziune 0,01mm

DIN 863/II

	A mm			
1658/25	0-25	016580025	€ 64,50	€ 44
1658/50	25-50	016580050	€ 70,50	€ 48
1658/75	50-100	016580075	€ 70,50	€ 54



1662/...

Ceas comparator
• diviziune 0,01mm
• grosime tijă 8mm

	mm			
1662/1	0-5	016620001	€ 75,50	€ 51
1662/2	0-10	016620010	€ 93,00	€ 62



DIN 868

1662SP0

Suport pentru ceas comparator
• baza magnetică
• dimensiuni bază 55x50x60mm (hxlxL)

016620800

~~€ 64,00~~ € 39



1838S

018380122

Lampă inspecție LED

~~€ 71,00~~ € 49

- Poate fi rotită 180 grade
- Lumină dublă, în față și în vârf
- 700 lumini / spot 200 lumini
- Corp anti-alunecare din cauciuc
- Cârlige prindere
- Magneți la bază și în spate pentru ajustabilitate crescută
- Cu încărcător 100-240V / 50-60Hz
- Timp încărcare: 4 ore
- Timp de funcționare: 2-7.5 ore



1838/11LED

018380111

Lampă inspecție LED

~~€ 135~~ € 79

- Corp compact cu mâner anti-alunecare
- Cârlig orientabil
- Magnet la bază
- Cu alimentator de 100-240V c.a. / 50-60Hz
- LED-uri laterale 320 lumini
- IP65
- Indicator încărcare



Geam de protecție ușor de schimbat



LED frontal



1833.. -reper nou

Lanteră inspecție LED, din aluminiu anodizat

- Focus reglabil
- 2 setări de luminozitate



1833 L

018330004

- durată baterie: 8,5 h
- L 300 mm

€ 44,50



1833 S

018330002

- durată baterie: 10.0 h
- L 150 mm

€ 21,50



1833 M

018330003

- durată baterie: 7.5 h
- L 162 mm

€ 27



1833 XL

018330005

- durată baterie: 22.0 h
- L 300 mm

€ 55



1838COB

Lampă de control compactă, reîncărcabilă, cu LED-uri de foarte mare putere, baterie litiu-polimer

- Corp compact din cauciuc anti-alunecare
- Cârlig orientabil
- Baza magnetică se poate roti cu 180 de grade
- Cu alimentator de 100-240V c.a. / 50-60Hz
- 55 / 110 lumini
- Intervalul de funcționare: 5 / 2,5 ore
- IP20

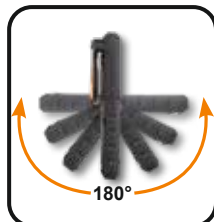

~~€ 76~~

€ 49



018380010

1838SLIM

018380221

Lanternă de inspecție reîncărcabilă, articulată, subțire cu 3 LED-uri

~~€ 60~~ € 39

- Bază magnetică
- Timp de încărcare: 2,5h
- Durata de viață a bateriei: 2-4h



Emisie triplă de lumină

- față: 100/200 lumeni
- spate: 180 lumeni
- capat: 80 lumeni

reîncărcabil



1837F

018370050

Lanternă magnetică, articulată cu LED-uri cu luminozitate ridicată fabricat din aluminiu anodizat

~~€ 70~~ € 48

- focalizare reglabilă
- 2 setări de luminozitate
- baterii: 3xAA (nu sunt incluse)
- durata de viață a bateriei: 14,5 ore
- indicator de încărcare



L 460 mm

DESIGN NOU

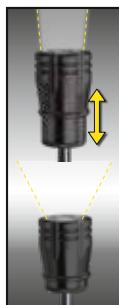

018370450

1837M

Proiector LED COLOR MATCH

- 3 setări de luminozitate: 500 / 1.000 / 2.000 lumeni
- CRI (index de redare a culorilor): 96+
- CCT (temperatura de culoare corelată): 2700K / 3500K / 4500K / 5500K / 6500K
- încărcător baterie: intrare: 100-240V c.a. - 50 / 60Hz; ieșire: 15V 1.5A
- conector de încărcare cu eliberare rapidă
- timpul de încărcare: 3,5 ore
- durata de viață a bateriei: 8/4/2 h
- indicator de încărcare
- temperatura butonului și a culorii LED-ului indicator
- buton și indicator de luminozitate LED
- se poate roti până la 180°
- IP65
- IK07



~~€ 240~~ € 159



96 CRI+

1837C

Proiector LED reîncărcabil

- 3 setări de luminozitate
- Încărcător baterie: intrare: 100-240V c.a. - 50 / 60Hz; ieșire: 15V 1.5A
- Timp de încărcare: 4 ore
- Indicator de încărcare cu 3 LED-uri
- Se poate roti până la 180°
- IP65
- IK07
- Prevazut bază magnetică aplicabilă



220x225x70 mm



	lumini			
1837C/2100	2100	018370210	€ 154	€ 99
1837C/4300	4300	018370430	€ 225	€ 149

Roboți de pornire, testere baterii

1498/12



12V

014980480



~~€ 585~~

€ 399

Robot de pornire portabil pentru autoturisme, 12V

DATE TEHNICE:

- Curent de anclanșare: 2200A
- Include cureaua de umăr
- Acumulator etanș cu plăci de plumb și acid sulfuric, electrolit (AGM) de tip solid

Battery



1498/24



12-24V

014980490



~~€ 1180~~

€ 790

Robot de pornire portabil pentru autoturisme și vehicule comerciale, 12-24V

DATE TEHNICE:

- Curent de anclanșare: 4200A (12V) - 2100A (24V)
- Include cureaua de umăr
- Acumulator etanș cu plăci de plumb și acid sulfuric, electrolit (AGM) de tip solid

1498TB/12-24

014980401

Tester digital de baterii, 12V, și analizor de pornire / încărcare, 12-24V

~~€ 557~~

€ 349

- permite testarea următoarelor: bateria, alternator (inteligent și normal) și start și test de masă
- prevăzut cu software pentru imprimare teste la PC
- afișaj iluminat
- carcasă compactă și rezistentă la șocuri
- software in 10 limbi, inclusiv RO
- complet cu intrare pentru conectarea unei mini imprimante (accesoriu opțional, Beta 1498ST / TB)



435x320x100 mm



Aplicații	- Tester baterie - Tester încărcare a alternatorului 12-24V - Test starter
Domeniu măsurare	100-2000 CCA
Standarde de referință	CCA, SAE, DIN, EN, IEC, JIS
Baterii suportate	PB, WET, GEL, AGM, AGM FLAT, EFB
Voltmetru	9V-36V
Lungime cablu	1600 mm
Limbi disponibile	Italiană, engleză, franceză, germană, spaniolă, poloneză, română, olandeză, suedeză și finlandeză
Accesorii incluse	Cablu, soft

1464T

014640050

Tester digital pentru presiune și compresie SPECIFICAȚII

~~€ 730~~ € 469

- display 5" touch screen
- baterie reîncărcabilă polymer lithium
- complet cu senzor de 80 bar (pentru presiunea joasă) și cablu USB

Folosind kit-ul 960AD/TP2, se pot testa următoarele:

- presiunea motoarelor benzină și diesel
- presiune de ulei
- presiunea joasă common rail
- presiune injecție motoare benzină

Folosind kit-ul 1464AP, se pot testa următoarele:

- presiunea circuitului common rail



960AD/TP2

009600510

Set adaptoare pentru testerul 1464T

~~€ 432~~ € 279

Conține:

- Injectoare false
- Bujii incandescente false
- Adaptoare bujii
- Adaptoare sondă ulei
- Cuple sistem injecție benzină
- Set garnituri

430x310x50 mm



1464AP

014640450

Set pentru testarea sistemului common rail de înaltă presiune, pentru testerul 1464T

~~€ 660~~ € 419

Conține:

- set furtune înaltă presiune
- adaptor
- senzor 2,000 bar

430x310x50 mm



1464CBD - reper nou

014640300

Set complet de accesorii pentru măsurarea compresiei motoarelor diesel și benzină pentru testerul 1464T.

~~€ 595~~ € 399

Conține:

- 44 bujii incandescente false
- 8 injectoare false
- 1 kit injector fals pentru camioane, motoare vapoare și mașini agricole
- 1 adaptor 90°, supapă de presiune și conducta de legătură
- loc special prevăzut pentru testerul 1464T



1464FG

014640470

Set de reglatoare false pentru testarea sistemului diesel common rail

Folosit cu testerul și adaptoarele potrivite, acesta face posibilă determinarea dacă problema este pompa de înaltă presiune sau regulatorul atunci când nu există presiune în circuit

Recomandat pentru reglatoare Bosch, Delphi, Denso și Siemens



~~€ 255~~

€ 174



014640550

1464PT

Set pentru testare presiune turbo, pentru testerul 1464T

conține senzor și cablu de conectare



~~€ 142~~

€ 95

1464APB

014640500

Set pentru testare presiune în motoarele FSI, pentru testerul 1464T

conține senzor 200 bari și conectori

~~€ 325~~

€ 217



1759

017590251

Refractometru, pentru testarea lichidului de răcire, a acidului de baterie, a lichidului pentru parbriz, și pentru AdBlue

- Etilen glicol: -25 +0 -50 °C
- Propilen glicol: -25 +0 -50 °C
- Acid baterie: 1,1-1,3kg/l
- Lichid parbriz: -25 -40 °C
- AdBlue : procent uree 30%-40%

~~€ 135~~

€ 85



1760DGT



01760005

~~€ 222~~

€ 149

Multimetru digital

Permite măsurarea turajului, voltajului și amperajului în curent DC și AC



RPM (tahometru)
 RPM4 600 - 4000 RPM
 RPM4 600 - 12000 RPM (x10 RPM)
 RPM2/DIS 300 - 4000 RPM
 RPM2/DIS 300 - 6000 RPM (x10 RPM)
 Dwell: 4-8 CYL
 Tensiune DC : 400mV-4/40/400/1000V
 Tensiune AC: 4/40/400/700V
 Intensitate DC: 40/400mA-4/20A
 Intensitate AC: 40/400mA-4/20A
 Rezistență: 400Ω-4/40/400kΩ-4/40MΩ
 Capacitate: 40/400nF-4/40/100μF
 Frecvență: 5/50/500Hz-50/500-10MHz
 Duty cycle: 0.1 % - 99.9%
 Amplitudine puls: 1 - 10ms
 Test diode: pina la 0.3mA
 Continuitate: <150Ω - <0.3mA
 Afișaj: LCD,
 Supravoltaj: Categoria II 1000V
 Oprire automată: 30 minute

1760B

~~€ 144~~

€ 99

Multimetru digital

Permite măsurarea voltajului și amperajului în curent DC și AC



Tensiune DC : 200 mV-2/20/200/1000V
 Tensiune AC : 2-20/200/700V
 Intensitate DC : 2/20/200 mA-20 A
 Intensitate AC : 2/200 mA- 20 A
 Rezistență: 200Ω - 2/20/200 kΩ - 2/20 MΩ
 Capacitate: 2/20/200 nF - 2/200 μF
 Temperatură: -20° + 1000°C/ -4 °F ~ +2000°F
 Frecvență: 20kHz
 Alimentare: baterie 1,9V (inclusa)

1760DGT/2- reper nou

Multimetru digital auto, portabil, cu osciloscop cu 2 canale și generator de forme de undă



199 mm
 40 mm
 98 mm

Kitul conține

- cabluri multimetrice
- 2 cabluri BNC
- sondă osciloscop (1X și 10X)
- încărcător de baterii
- teacă de nailon

DATE TEHNICE

Display:	2.8" colour TFT
Rezolu	320 x 240 pixels
Alimentare	100V-240V AC, 50Hz-60Hz; DC INPUT 5V DC-2A
Battery:	2 x 2600 mAh



01760008

~~€ 620~~

€ 399

SPECIFICAȚII OSCILOSCOP

Orizontală

Lățime de bandă: 40MHz
 Gama de frecvență de eșantionare: 250MSa / s (canal unic) - 125MSa / s (canal dublu)
 Gama SEC / DIV: 5ns / div + 500s / div 1,2,5 secvență

Vertical

Gama VOLTS / DIV: intrare BNC 10mV / div ÷ 10V / divat
 Analog selectabil, limită de lățime de bandă, tipic: 20MHz
 Răspuns de joasă frecvență (-3db): ≤10Hz a BNC
 Precizie de câștig DC: ± 3% pentru modul de achiziție normal sau mediu,
 10V / div ÷ 10 mV / div

Declanșator

Tipul: Edge
 Mod: Auto, Normal, Single
 Panta: în creștere, cădere, în creștere și cădere
 Sursa: CH1, CH2

Intrare

Cuplaj:
 DC, AC sau GND

Factori de atenuare a sondei acceptate: 1X, 10X, 100X, 1000X

Generator de forme de undă arbitrar

Frecvența formei de undă: sinusoidal (1Hz ÷ 25MHz), pătrat (1Hz ÷ 10MHz),
 Rampă (1Hz ÷ MHz), EXP (1Hz ÷ 5MHz)
 Lățime: 2.5Vpp (50Ω) - 5Vpp (impedanță ridicată)
 Impedanță de ieșire: 50Ω

1740B 280

017400280

~~€ 61,50~~

€ 39

2,4÷4,8 mm steel



Clește de nituit compact

- Raport de transmisie optimizat prin pârghii
- sistem de prindere cu 3 bacuri
- Capăt reglabil pentru tragerea niturilor în 2-5 pași.

1740B 330

017400330

~~€ 71,50~~

€ 49

3,2÷6,4 mm steel



3 bacuri:
prindere solidă a
nitului



1750 500

017500500

Gresor manual, 500 cc

~~€ 35~~

€ 24

550 Bar



1742

017420001

Clește pentru piulițe încasetate, cu
trăgătoare de M3, M4, M5, M6

~~€ 107,50~~

€ 72



960KC-M....

Set scule speciale pentru înlocuirea bujiilor incandescente rupte sau deteriorate

≡ 380x290x50 mm



009600801

~~€ 362~~

€ 220



Pentru bujii
filetate
M8-M9-M10

1759HD/3

Dispozitiv de testare a etanșeității și de umplere a circuitelor de răcire

Dau posibilitatea testării sub presiune a etanșeității circuitelor (conduce, racorduri, pompe, radiatoare) și umplerii rapide a circuitelor, cu evitarea formării de bule de aer

017590063

~~€ 475~~

€ 290

≡ 600x500x140 mm



960T/C11 reper nou

Set dispozitive scoaterea/instalarea senzorilor

009600031

~~€ 162~~

€ 109

Setul conține:

- 1 tubulară hexagonală cu capăt dublu, dimensiune 1" - 11/16" pentru senzori de presiune a uleiului
- 1 tubulară hexagonală cu capăt deschis, 29 mm, pentru senzori de oxigen
- 1 tubulară bi-hexagonală cu capăt deschis, 27 mm, pentru injectoare
- 1 tubulară hexagonală cu capăt deschis, 22 mm, pentru vacuostate
- 1 tubulară hexagonală cu capăt deschis, 22 mm, lungime 80 mm, pentru senzori de oxigen
- 1 tubulară hexagonală cu capăt deschis, 22 mm, lungime 90 mm, pentru senzori de oxigen
- 1 tubulară hexagonală cu capăt deschis, 22 mm, compactă, lungă de 30 mm, pentru senzorii de oxigen
- 1 tubulară hexagonală cu capăt deschis, 22 mm, compactă, 50 mm lungime, pentru senzorii de oxigen
- 1 tubulară hexagonală și bi-hexagonală, 22 mm, compact, 34 mm lungime, pentru senzorii de oxigen
- 1 tubulară hexagonală cu capăt deschis, 22 mm, în formă de tub
- 1 M18x1.5



≡ 330x270x25 mm

1471M/C22

014710101

Dispozitiv pneumatic pentru împingerea înapoi și rotirea pistoanelor discurilor de frână dreapta și stânga, cu accesorii, în cutie din plastic

~~€ 255~~ € 139

- Împingere automată
- Forța de împingere: 150 kg
- Presiunea de lucru 5÷8 bari



350x310x85 mm

960P

009600777

Tester de vacuum

- supapă dublu sens presiune / depresiune
- set accesorii și adaptoare

~~€ 215~~ € 119

350x320x95 mm



1497/C23

014970200

Set 23 scule pentru conectori

~~€ 188~~ € 130



430x310x50 mm

1472AU

014720100

~~€ 109~~ € 75



Clește automat pentru coliere

- diametru acționare 18 - 53 mm
- lungime 275 mm



1472AU/P

014720105

~~€ 96~~ € 66

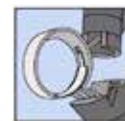

Clește automat pentru coliere, cu extensie

- diametru acționare 18 - 54 mm
- lungime 630 mm



1473P

014730020

~~€ 30,50~~ € 21



Pentru
colierele de
planetare

Clește pentru coliere OETIKER®, subțiri

- diametru maxim 53 mm
- lungime 210 mm



1473A

014730010

~~€ 81,50~~ € 56



Clește pentru coliere OETIKER®

- diametru maxim 53 mm
- lungime 210 mm



1482B

014820021

~~€ 39~~ € 27

Clește pentru cuple rapide de combustibil

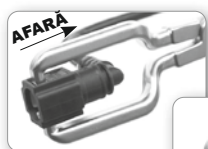

AFĂRĂ



INAUNTRU



1884

018840010

Pompă de umplere cu ulei a cutiilor de viteze manuale, automate și a diferențialelor

Dispune de 12 adaptoare pentru conexiunea directă

- Prevăzută cu o supapă de reținere pentru umplerea cu ulei fără scurgeri
- Capacitate: 70 cc la o cursă a pompei
- Capacitatea rezervorului: 7,5 l
- Vâscozitatea maximă permisă a uleiului: SAE 140



~~€ 400~~

€ 269

12 ADAPTORS

FORD	AT-101
UNIVERSAL (Bmw, Honda, Nissan...)	AT-102
VW-AUDI	AT-103
VW-AUDI-PORSCHE	AT-104
VW-AUDI-MINI COOPER	AT-105
MERCEDES	AT-106
DSG	AT-107
VW-AUDI CVT	AT-108
VOLVO	AT-109
TOYOTA-LEXUS	AT-110
SKODA	AT-111
VW Passat/Tiguan <2007	AT-112

1756C

017560502

Seringă ulei, 200 ml, fabricată din polipropilenă

- se poate folosi și cu lichidul de frână
- garnitură dublă din EPDM
- temperatura de lucru: +0 - +50 °C
- Nu este adecvată pentru combustibil

~~€ 29~~

€ 20



200 ml

1756D

017560515

Seringă ulei, 1500 ml, fabricată din polipropilenă

- garnitură dublă din NBR
- temperatura de lucru: +0 - +50 °C
- Nu este adecvată pentru combustibil

~~€ 65~~

€ 45,50



1500 ml

1493/S

38" 12"

014930074

Cheie filtru ulei, cu 3 brațe, pentru strângere dreapta și stânga

~~€ 71,50~~

€ 49



80-115mm

1488L

014880050

Cheie filtru ulei cu lanț dublu

~~€ 85~~

€ 59



60-160mm

1500N

Presă extractoare cu 2 brațe culisante

	A min÷Max	Charge Max kg			
1500N/1	23÷70 mm	6000	015000601	€ 65	€ 46
1500N/2	23÷100 mm	6000	015000602	€ 71	€ 50
1500N/3	35÷140 mm	10000	015000603	€ 117,50	€ 82
1500N/4	35÷190 mm	10000	015000604	€ 126,50	€ 89



1535/C1

015350001

~~€ 267~~ € 187

	L mm	A min÷Max
1533PR/1	100	
1533/2	150	45÷130 mm
1534/1	88	5÷60 mm

260x180x40 mm



1535/C2

015350002

~~€ 282~~ € 197

	L mm	A min÷Max
1533PR/1	100	
1533/2	150	45÷130 mm
1534/2	118	12÷75 mm

260x180x40 mm

1535/C3

015350003

~~€ 455~~ € 318

	L mm	A min÷Max
1533PR/2	100	
1533/3	210	85÷225 mm
1534/3	160	22÷115 mm

380x280x55 mm

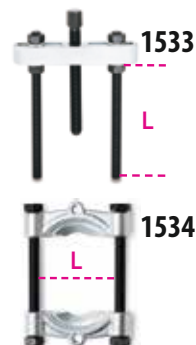

1517

Presă extractoare cu 3 brațe, cu prindere automată

- deschidere simultană a brațelor
- efect de autoblocare
- piuliță dublă



	forța Max kg	A min÷Max	○ mm	● mm			
1517/90	6000	18÷90 mm	22	19	015170000	€ 218	€ 152
1517/150	6000	25÷150 mm	22	19	015170010	€ 223	€ 156
1517/200	6000	40÷200 mm	22	19	015170020	€ 257	€ 179
1517/260	8000	50÷260 mm	30	27	015170030	€ 299	€ 209



1547/C6

015470006

Presă extractoare pentru rulmenți cu bile

~~€ 235~~

€ 159

Rulmenți
1547/1
6011-6014, 6206-6211, 6303-6308, 6403-6405 1
1547/2
6004-6010, 6200-6205, 6300-6304



420x185x60 mm



1545/C5M

015450011

Presă extractoare pentru interior

~~€ 455~~

€ 309

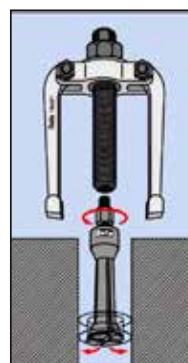

	A mm	C mm
1544/1	9÷12	0,80
1544/2	13÷17	1,15
1544/3	16÷21	1,70
1544/4	20÷25	1,65
1544/5	25÷30	2,00



420x185x60 mm

1428/SB11

014280111

Set tubulare elicoidale pentru desfacere piulițe deteriorate

~~€ 182~~

€ 119



38 8-10-11-12-13-14 mm 12 15-16-17-18-19 mm



1559/22

015590001

~~€ 72~~ € 50

Presă articulație

- deschidere 50 mm
- diametru acționare 18 - 22 mm



1560/1

015600001

~~€ 122~~ € 85

Presă pivot

- deschidere 12 - 50 mm
- diametru acționare 20 mm



1566N

Cheie bieletă

- permite demontarea/montarea bieletelor de direcție
- acționare cu cheie de 27 mm



	Actio- nare	o min ÷ Max	L mm	● mm	📄	€
45 x 190	1/2"	35÷45 mm	190	27	015660008	€ 102 € 71
45 x 400	1/2"	35÷45 mm	400	27	015660010	€ 114 € 80

1556/1A

015560101

~~€ 195~~ € 136

Presă arcuri

- deschidere 65-320 mm



1712E/L1

017120111

~~€ 36,50~~ € 25

Recuperator magnetic, flexibil, cu LED

- capacitate recuperare 750 g
- lungime 500 mm



1715FL/B

017150115

~~€ 39~~ € 27

Oglindă flexibilă cu iluminare

- dimensiune oglindă 53 x 90 mm
- lungime 533 mm



920INOX/C16

009203916





Set de 15 tubulare bihexagonale și cheie cu clichet, din inox, în cutie

~~€ 979~~

€ 669

Sculele din inox Beta pot fi sterilizate în autoclavă la 121 °C

	920INOX-A	○	10-12-13-14-15-16-17-18-19 21-22-24-27-30-32mm
	920/55INOX	⊗	



1150INOX 180

011500518

Clește patent fabricat din inox, 180mm

INOX

~~€ 88~~

€ 59



42INOX/SC9

000420387

Set de 9 chei combinate, fabricate din inox, în suport compact

INOX

~~€ 157~~

€ 99



8-10-11-12-13-14-15-17-19 mm



1293INOX/D8

012930408

Set de 8 șurubelnițe combinate, fabricate din inox

~~€ 69~~

€ 47

1290INOX ● 2,5x50-3x75-4x100
5,5x150-6,5x150 mm

INOX

1292INOX ⊕ PH0x60-PH1x80
PH2x100 mm



1273MQ/D6

012730851

Set 6 șurubelnițe combinate, izolate 1000V

~~€ 57~~ € 39

1274MQ ● 3x100-4x100-5,5x125 mm
1272MQ ⊕ PH0x60-PH1x80-PH2x100 mm



1273MQ/F-D6

012730406

Set 6 șurubelnițe combinate, slim, izolate 1000V

~~€ 66~~ € 45,50

1274MQ/F ● 0.5x3,5x100 - 0.8x4,5x100 -
1x5,5x125 - 1.2x6,5x150 mm
1272MQ/F ⊕ PH1x4.5x80- PH2x6x100 mm



1169MQ/D2

011690143

Set patent și sfic izolați 1000V

~~€ 82,50~~ € 55



1082MQ 160 mm

1150MQ 180 mm

2115PL-MQ32 reper nou

021150332

Set scule izolate 1000V, în cutie mobilă de plastic

~~€ 984~~ € 590

- | | |
|--|------------|
| 1 Clichet reversibil 1/2", izolat 1000V | 920MQ/55A |
| 1 Cheie inelară cotită 10-12 mm, izolată 1000V | 89MQ |
| 1 Adaptor biți 1/4", izolat 1000V | 850MQ |
| 10 Set 10 biți Torx T7-T8-T9-T10-T15-T20-T25-T27-T30-T40, izolat 1000V | 860TX/A10 |
| 7 Tubulare hexagonale 1/2" 8-10-12-13-14-17-19 mm, izolate 1000V | 920MQ/A |
| 1 Preungitor 1/2" 125mm, izolat 1000V | 920MQ/21 |
| 1 Prelungitor 1/2", izolat 1000V | 920MQ/22 |
| 1 Clește reglabil 250mm, izolat 1000V | 1048MQ 250 |
| 1 Clește patent 180mm, izolat 1000V | 1150MQ |
| 1 Clește șpiț cu vârf indoit 160mm, izolat 1000V | 1164MQ 160 |
| 2 Șurubelniță cruce 4.5X80-6X100mm, izolata 1000V | 1272MQ |
| 3 Șurubelniță dreaptă 3X100-4X100-5.5X125, 1000V | 1274MQ |
| 1 Mănuși izolate 1000V | 1995MQ/G2 |
| 1 Cutie plastic pentru depozitare dimensiune 558 x 277 x 270mm | CP15L |



1365/K13

013650013

~~€ 565~~

€ 390

Kit impins caroserii, în cutie mobilă de plastic

Setul conține:

- pompă hidraulică 10 tf, cu furtun de 1,5m
- piston 10 tf
- pană dublă hidraulică; capacitate: 500 kg
- terminal plat, 150x90 mm
- terminal tip "L", 50x50 mm
- terminal cu patru colțuri
- terminal rotund, Ø 50 mm
- terminal tip pană, 43 mm
- prelungitor 240-mm
- prelungitor 450-mm
- prelungitor 475-mm
- terminal rotund cauciuc
- cuplaj piese

900x420x180 mm



1369/C11

013690033

~~€ 677~~

€ 440

Set scule tinichigerie

format din:

- 6 corpuri tinichigerie
- lingură tinichigerie 385mm
- răsfil cu pila silex
- ciocan cu capete de plastic
- 2 ciocane de tinichigerie
- în cutie metalică



3002

030020001

Pat și scaun de lucru

- Ramă de otel
- suport din PVC umplut cu spumă
- ușor de transformat în pat sau scaun de lucru



~~€ 95,00~~

€ 59

3003C

030030100

Pat de lucru din plastic antișoc

- Zona lombară și a capului cu finisare și textură carbon
- plăci metalice în zona superioară pentru fixarea accesoriilor magentice
- 6 roți , diametru 79mm
- Capac max.sușținere 120kg



~~€ 199~~

€ 129



3010T

Suport susținere, pereche



H

	Max kg	H min mm	H Max mm		
3010/T2	2000	280	425	030100002	€ 55
3010/T3	3000	285	430	030100003	€ 66
3010/T6	6000	400	580	030100006	€ 89
3010/T10	10000	471	735	030100010	€ 166

3011T

Cric hidraulic



H

	Max kg	H min mm	H Max mm		
3011/T5	3000	285	430	030110050	€ 64
3011/T10	6000	400	580	030110100	€ 96
3011/T15	10000	471	735	030110150	€ 119
3011/T20	20000	245	521	030110200	€ 169

3030/2T



030300020

Cric auto hidraulic cu platformă joasă, de 2t, cu 6 roți

~~€ 670~~

€ 390

- Cricul poate fi manevrat cu ușurință pe pardoseli neorizontale, neregulate
- Înălțimea minimă a platformei: 85 mm
- Înălțimea maximă a platformei: 520 mm
- Lungimea: 860 mm
- Lățimea: 400 mm



**Stabil,
ușor de manevrat**



Pedala permite manevrarea cu ușurință



Roți frontale duble, înclinabile, făcute din plastic (PTFE)

H min 85 mm

3026/...



Cric cutie de viteze

- Acționare la pedală
- Cilindru hidraulic cromat
- 4 roți orientabile 360°

0,3T	030260003	€ 585	€ 409
0,5T	030260005	€ 695	€ 450
1.0T	030260010	€ 840	€ 550



1927XM



Pistol pneumatic de impact

- Incredibil de compact și de puternic
- Pârghie schimbare sens de acționare
- Trei poziții de reglare a puterii de acționare
- Evacuare aer prin mâner
- Cirlig echilibrare pozitie

**Ultra compact
si puternic 770 Nm**

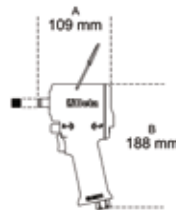

019270030

~~€ 243~~ € 159

1,3 kg



Turație liberă	rpm	10.000
Dispozitiv de acționare		„Single hammer”
Cuplu maxim	Nm	770
Domeniu utilizare	Cl 8.8	M22-34 mm
Domeniu utilizare	Cl 12.9	M18-27 mm
Admisie de aer	GAS	1/4”
Presiunea de lucru	Bari	6,2
Dimensiunea interioară a furtunului (Ø)	mm	10
Consumul mediu de aer	l/min	160
Greutatea	Kg	1,3

1927B



Pistol pneumatic de impact

- Dispozitiv de impuls „Pin Clutch”
- Mâner cauciuc
- Manetă reversibilă
- Trei poziții de reglare a puterii de acționare
- Evacuare aer prin mâner

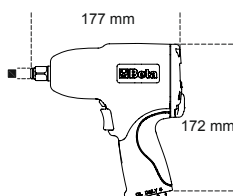

019270022

~~€ 160~~ € 109

Turație liberă	rpm	7.000
Dispozitiv de acționare		„Pin Clutch”
Cuplu maxim	Nm	705
Domeniu utilizare	Cl 8.8	M22-34mm
Domeniu utilizare	Cl 12.9	M18-27mm
Admisie de aer	GAS	1/4”
Presiunea de lucru	Bari	6,2
Dimensiunea interioară a furtunului (Ø)	mm	10
Consumul mediu de aer	l/min	133

1927CD



Pistol pneumatic de impact, material compozit

- Ușor și echilibrat pentru mai mare ușurință la utilizare

**CUPLU
1.020 Nm**

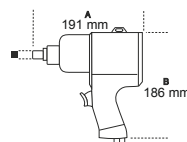

019270007

~~€ 375~~ € 179

1,9 kg

Turație liberă	rpm	7.000
Dispozitiv de acționare		„Double hammer”
Cuplu maxim	Nm	1.020
Domeniu utilizare	Cl 8.8	M22-34mm
Domeniu utilizare	Cl 12.9	M18-27mm
Admisie de aer	GAS	1/4”
Presiunea de lucru	Bari	6,2
Dimensiunea interioară a furtunului (Ø)	mm	10
Consumul mediu de aer	l/min	130

1927P



019270008

Pistol pneumatic de impact, material compozit

- Ușor și echilibrat pentru mai mare ușurință la utilizare
- Pârghie schimbare sens de acționare
- Trei poziții de reglare a puterii de acționare
- Evacuare aer prin mâner



~~€ 410~~

€ 209

2 kg

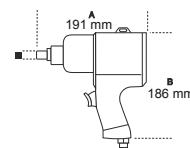

Turație liberă	rpm	7.500
Dispozitiv de acționare		„Double hammer”
Cuplu maxim	Nm	1.750
Domeniu utilizare	Cl 8.8	M24-36 mm
Domeniu utilizare	Cl 12.9	M20-30 mm
Admisie de aer	GAS	1/4”
Presiunea de lucru	Bari	6,2
Dimensiunea interioară a furtunului (Ø)	mm	10
Consumul mediu de aer	l/min	290



**CUPLU
1.750 Nm**



720/C6



007200910

Set de 6 tubulare scurte de impact, în cutie de metal

- mărimi: 13-14-17-19-22-24 mm

~~€ 83~~ **€ 39**

195x80x85 mm



720/C12



007200912

Set de 12 tubulare scurte de impact, în cutie de metal

- mărimi: 10-11-12-13-14-17-19-22-24-27-30-32 mm

~~€ 157,50~~ **€ 69**

195x80x85 mm



720LC/C3



007200653

Set de 3 tubulare lungi pentru roți, cu protecție din inserții polimerice

- mărimi: 17 - 19 - 21 mm

~~€ 33,50~~ **€ 19**

148x132x44 mm



1927SP-AM

019270000

Suport magnetic pentru pistol pneumatic

~~€ 48,50~~ **€ 34**

- Dotat cu doi magneți puternici, acoperiți cu peliculă de cauciuc
- Pentru un pistol pneumatic de 1/2”, 4 tubulare și o cheie dinamometrică
- Capacitate: 10 kg



1928K4 3/4" CE

Set pistol pneumatic și patru tubulare de impact, seria lungă

- Pârghie schimbare sens de acționare
- Trei poziții de reglare a puterii de acționare
- Evacuare aer prin mâner
- Mâner anti-alunecare

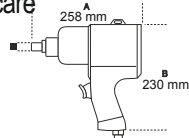

5,2 kg

728L 27-30-32-36 mm



019280104

~~€ 713~~ **€ 390**

Turație liberă	rpm	4.000
Dispozitiv de acționare		„Pin Clutch”
Cuplu maxim	Nm	1.493
Domeniu utilizare	Cl 8.8	M27-41mm
Domeniu utilizare	Cl 12.9	M24-36mm
Admisie de aer	GAS	3/8"
Presiunea de lucru	Bari	6,2
Dimensiunea interioară a furtunului (Ø)	mm	10
Consumul mediu de aer	l/min	260
Greutatea	Kg	9,3

410x330x106 mm

1928CD 3/4" CE

Pistol pneumatic de impact, material compozit

- Dispozitiv de acționare „Double hammer”
- Raport foarte bun greutate/putere
- Pârghie schimbare sens de acționare
- Trei poziții de reglare a puterii de acționare
- Evacuare aer prin mâner
- Atenuator de zgomot

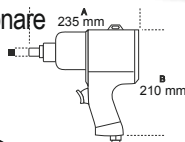

3,5 kg



019280007

~~€ 897~~ **€ 489**

Turație liberă	rpm	4.500
Cuplu maxim	Nm	1.800
Domeniu utilizare	Cl 8.8	M27-41mm
Domeniu utilizare	Cl 12.9	M24-36mm
Admisie de aer	GAS	3/8"
Presiunea de lucru	Bari	6,2
Dimensiunea interioară a furtunului (Ø)	mm	10
Consumul mediu de aer	l/min	215

1928XM 3/4" CE

Pistol pneumatic de impact, ultra-compact

- Dispozitiv de acționare „Double hammer”
- Raport foarte bun greutate/putere
- Pârghie schimbare sens de acționare
- Trei poziții de reglare a puterii de acționare
- Evacuare aer prin mâner

Ultra compact și puternic

2,9 kg



019280030

~~€ 483~~ **€ 333**

Turație liberă	rpm	4.800
Cuplu maxim	Nm	1.600
Domeniu utilizare	Cl 8.8	M27-41mm
Domeniu utilizare	Cl 12.9	M24-36mm
Admisie de aer	GAS	3/8"
Presiunea de lucru	Bari	6,2
Dimensiunea interioară a furtunului (Ø)	mm	10
Consumul mediu de aer	l/min	175

728/C10 3/4"

Set de 10 tubulare scurte de impact, acționare 3/4"

- mărimi: 17-19-22-24-27-30-32-36-41-46

~~€ 286~~ **€ 139**

007280910



275x120x65 mm

728L...

Tubulară lungă de impact, acționare 3/4"



	L mm	Ø mm		
728L24	90	24	007280324	€ 24
728L27	90	27	007280327	€ 24
728L30	90	30	007280330	€ 25
728L32	90	32	007280332	€ 27

1930HLA



019300040

Pistol pneumatic de impact

- Dispozitiv de acționare „Double hammer”
- Ax de acționare extra-lung
- Mâner auxiliar
- Pârghie schimbare sens de acționare
- Trei poziții de reglare a puterii de acționare
- Evacuare superioară

16,4 kg

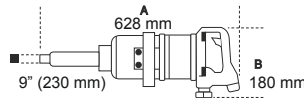

~~€ 1.520~~

€ 920



CUPLU
3.661 Nm

Turație liberă	rpm	3.000
Dispozitiv de acționare		„Double hammer”
Cuplu maxim	Nm	3661
Domeniu utilizare	CI 8.8	M42-65mm
Domeniu utilizare	CI 12.9	M33-50mm
Admisie de aer	GAS	1/2"
Presiunea de lucru	Bari	6,2
Dimensiunea interioară a furtunului (Ø)	mm	13
Consumul mediu de aer	l/min	460

1930LA



019300037

Pistol pneumatic de impact

- Dispozitiv de acționare „Double hammer”
- Ax de acționare de 8"
- Mâner auxiliar
- Pârghie schimbare sens de acționare
- Trei poziții de reglare a puterii de acționare
- Evacuare superioară

10,6 kg

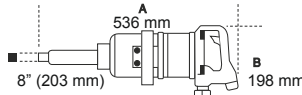

~~€ 1.100~~

€ 660



Turație liberă	rpm	4.000
Dispozitiv de acționare		„Double hammer”
Cuplu maxim	Nm	2.455
Domeniu utilizare	CI 8.8	M36-55mm
Domeniu utilizare	CI 12.9	M30-46mm
Admisie de aer	GAS	1/2"
Presiunea de lucru	Bari	6,2
Dimensiunea interioară a furtunului (Ø)	mm	13
Consumul mediu de aer	l/min	460

1930PA



019300032

Pistol pneumatic de impact

- Dispozitiv de acționare „Double hammer”
- Mâner auxiliar
- Pârghie schimbare sens de acționare
- Trei poziții de reglare a puterii de acționare
- Evacuare superioară

9,6 kg

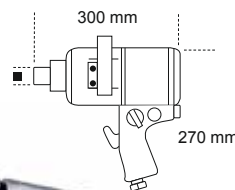

~~€ 1.045~~

€ 690



Turație liberă	rpm	3500
Dispozitiv de acționare		„Double hammer”
Cuplu maxim	Nm	2.455
Domeniu utilizare	CI 8.8	M36-55mm
Domeniu utilizare	CI 12.9	M30-46mm
Admisie de aer	GAS	1/2"
Presiunea de lucru	Bari	6,2
Dimensiunea interioară a furtunului (Ø)	mm	13
Consumul mediu de aer	l/min	350

729L...

Tubulară lungă de impact, acționare 1"

	L mm	Ø mm		
729L24	108	24	007290324	€ 42
729L27	108	27	007290327	€ 42
729L30	108	30	007290330	€ 42
729L32	108	32	007290332	€ 42



1921M1



019210005

Clichet pneumatic

- Extrem de ușor și compact
- Carcasă din material compozit
- Buton de reglare a turației
- Evacuare aer silențioasă

0,4
kg



~~€ 184~~ € 129

Turație liberă	rpm	200
Cuplu maxim	Nm	27
Domeniu utilizare	Cl 8.8	M7-11 mm
Domeniu utilizare	Cl 12.9	M6-10 mm
Admisie de aer	GAS	1/4"
Presiunea de lucru	Bari	6,2
Dimensiunea interioară a furtunului (Ø)	mm	8
Consumul mediu de aer	l/min	96

1921N3



019210025

Clichet pneumatic

- Extrem de ușor și compact
- Carcasă din material compozit
- Buton de reglare a turației
- Evacuare aer silențioasă

1,2
kg



~~€ 184~~ € 127

Turație liberă	rpm	150
Cuplu maxim	Nm	68
Domeniu utilizare	Cl 8.8	M10-16 mm
Domeniu utilizare	Cl 12.9	M8-13 mm
Admisie de aer	GAS	1/4"
Presiunea de lucru	Bari	6,2
Dimensiunea interioară a furtunului (Ø)	mm	10
Consumul mediu de aer	l/min	140

1931CD10



019310010

Mașină de găurit pneumatică, reversibilă

- Foarte ușoară și versatilă
- Mandrină cu autostrângere
- Carcasă material compozit
- Pârghie de schimbare sens pe ambele părți ale mașinii
- Evacuare aer silențioasă, prin mână

Turație liberă	rpm	1.800
Putere	kW	0,38
Capacitate mandrină	mm	1 - 10
Filet ax		3/8 - 24UNF
Admisie de aer	GAS	1/4"
Presiunea de lucru	Bari	6,2
Dimensiunea interioară a furtunului (Ø)	mm	10
Consumul mediu de aer	l/min	170

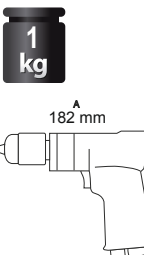

~~€ 198~~ € 135



1931AN10



019310030

Mașină de găurit pneumatică reversibilă, unghiulară

- Foarte ușoară și versatilă
- Mandrină cu autostrângere
- Carcasă material compozit
- Pârghie de schimbare sens pe ambele părți ale mașinii
- Evacuare aer silențioasă, prin mână

1,1
kg

Turație liberă	rpm	1.400
Putere	kW	0,38
Capacitate mandrina	mm	1 - 10
Filet ax		3/8 - 24UNF
Admisie de aer	GAS	1/4"
Presiunea de lucru	Bari	6,2
Dimensiunea interioară a furtunului (Ø)	mm	10
Consumul mediu de aer	l/min	150

~~€ 220~~ € 154



1937KL



Minișlefuitor orbital

019370161

~~€ 239~~

€ 165

- Furnizat cu doi bureți polishat Ø90 mm și disc blană
- Diametrul disc Ø75mm
- Greutate proprie 640g
- Greutate kit 1,8kg



Turație liberă	rpm	3200
Puterea	kW	0,25
Diametrul discului	mm	75
Filetul axului		M6x1.0
Admisie de aer	GAS	1/4"
Presiunea de lucru	Bar	6,2
Dimensiunea interioară a furtunului (Ø)	mm	10
Consumul mediu de aer	l/min	91

1933



Biax pneumatic

019330001

~~€ 117~~

€ 79

- Foarte ușor și practic
- Regulator viteză de rotație
- Pârghie de protecție pentru acționare accidentală
- Mandrină pentru diametru



0,38 kg

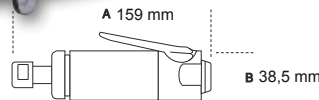

Turație liberă	rpm	25.000
Putere	kW	0,2
Capacitate mandrină	mm	3-6
Filet ax	M	14
Admisie de aer	GAS	1/4"
Presiunea de lucru	Bar	6,2
Dimensiunea interioară a furtunului (Ø)	mm	10
Consumul mediu de aer	l/min	230

1942A



Fierăstrău pneumatic

019420000

~~€ 269~~

€ 179

- Puternic și ușor de folosit
- Conceput pentru tăierea caroseriilor, a țevilor și tobelor de eșapament, a aluminiului și plasticului
- Cu mâner de cauciuc, țevă de evacuare și furtun pneumatic
- Evacuare posterioară

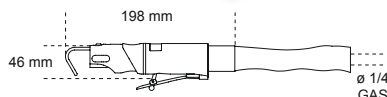
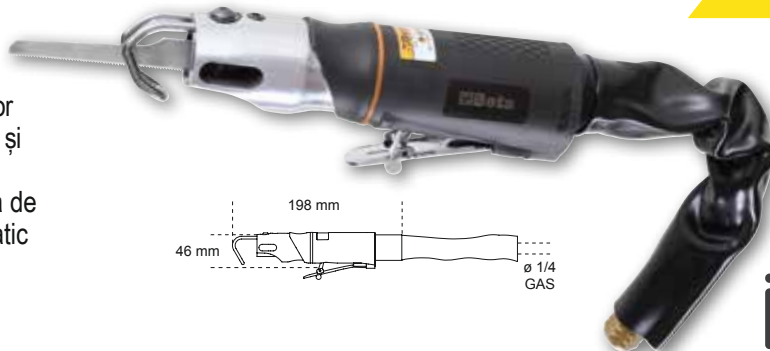

550 g

Curse pe minut		10.000
Lungimea cursei	mm	10
Admisie de aer	GAS	1/4"
Presiunea de lucru	Bar	6,2
Dimensiunea interioară a furtunului (Ø)	mm	8
Consumul mediu de aer	l/min	75

1946C4,8



Pistol pneumatic de nituit cu aspirație automată

- Pistol de nituit pneumatic profesional pentru nituri de 2,4 - 3,2 - 4,0 - 4,8 mm, pentru nituri din aluminiu, cupru și inox
- Ajustaj conic
- puternic și ușor de manevrat, cu mâner din material compozit
- Include un container pentru cozi de nituri și ulei pentru pistol

1,5 kg

Puterea de tracțiune	N	8900			
Lungimea cursei	mm	15			
Presiunea de lucru	Bar	6,2			
Admisie de aer	GAS	1/4"			
Consumul de aer	l/ciclu	2,6			
Dimensiunea interioară a furtunului (Ø)	mm	10			
Capacitatea maximă a niturilor	oțel inox Ø mm	4,8			
Material/ Pistol de nituit	2,4	3,2	4	4,8	
	cupru	✓	✓	✓	✓
	aluminiu	✓	✓	✓	✓
	oțel	✓	✓	✓	✓
	oțel inox	✓	✓	✓	✓

019460006

~~€ 512~~

€ 330



1946C7,8



Pistol pneumatic de nituit

- Pistol de nituit pneumatic profesional pentru nituri de 4,8 - 5,6 - 6,4 - 7,8 mm, pentru nituri din aluminiu, cupru și inox
- Ajustaj conic
- puternic și ușor de manevrat, cu mâner din material compozit
- Include un container pentru cozi de nituri și ulei pentru pistol

1,8 kg

Material/ Pistol de nituit	4,8	5,6	6,4	7,8	
	cupru	✓	✓	✓	✓
	aluminiu	✓	✓	✓	✓
	oțel	✓	✓	✓	✓
	oțel inox	✓	✓	✓	✓

Puterea de tracțiune	N	16.900
Lungimea cursei	mm	22,5
Presiunea de lucru	Bar	6,2
Admisie de aer	GAS	1/4"
Consumul de aer	l/ciclu	4,9
Dimensiunea interioară a furtunului (Ø)	mm	10
Capacitatea maximă a niturilor	oțel inox Ø mm	7,8

019460008

~~€ 805~~

€ 499



1940

Ciocan pneumatic

- Poate fi folosit la tăierea șuruburilor, bolților
- Realizat pentru folosire intensivă și îndelungată
- Livrat cu arc de reținere pentru dălți



019400001

~~€ 162~~

€ 109

Găuri per minut		3.500
Dimensiune daltă	Ø mm	11
Dimensiunea pistolului	mm	19
Dimensiunea găurii	mm	67
Admisie de aer	GAS	1/4"
Presiunea de lucru	Bar	6,2
Dimensiunea interioară a furtunului (Ø)	mm	8
Consumul mediu de aer	l/min	240

2 kg

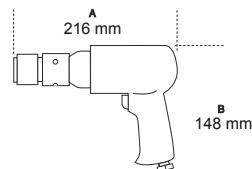

1940/S5

Set dălți pentru 1940

- 5 piese
- acționare hexagon 10mm



019400030

~~€ 59~~

€ 40

1949GPN



019490011

Pistol de umflat pneuri, profesional

- Carcasă din plastic ABS rezistentă la șocuri
- Cele două butoane speciale de introdus presiune (+) și de scos presiune (-) permit umflare și dezumflarea rapidă și exactă a pneurilor
- Admisie a aerului pentru furtun de cauciuc cu diametrul Ø 7 mm
- Lungime furtun 1500 mm



0,8 kg

~~€ 224~~

€ 139

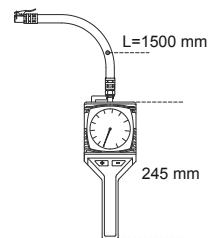

1949GPE

Pistol de umflat pneuri, profesional

- Presiunea de lucru: 0÷11 bari /10÷160 psi
- Funcție de reducere a presiunii
- Funcție de măsurare a presiunii
- Manometrul este îmbrăcat în cauciuc rezistent la șocuri
- Rotire de 360 de grade a furtunului



640 g

~~€ 110~~

€ 75

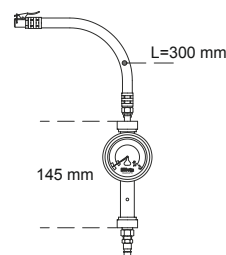

019490008

1919F1/4

Baterie filtrantă cu regulator și lubrifiant

Filet de intrare/ ieșire	GAS BSPT	1/4"
Capacitatea maximă de aer	l/min	1000
Presiunea maximă (de alimentare)	Bari	9,5
Presiune de lucru	Bari	0,5-8,5
Temperatura de lucru	°C	5÷60
Capacitate filtrare	micron	5
Capacitate rezervor	cc	60 aer/ 90 ulei

019190250

~~€ 142~~

€ 89

1919F1/2

Baterie filtrantă cu regulator și lubrifiant

Filet de intrare/ ieșire	GAS BSPT	1/2"
Capacitatea maximă de aer	l/min	2500
Presiunea maximă (de alimentare)	Bari	9,5
Presiune de lucru	Bari	0,5-8,5
Temperatura de lucru	°C	5÷60
Capacitate filtrare	micron	5
Capacitate rezervor	cc	60 aer/ 90 ulei

019190450

~~€ 142~~

€ 89



1915B

Furtun aer comprimat, din poliuretan

- lungime maximă 9m
- diametru interior 8mm
- diametru exterior 12mm
- conexiune cuple 1/4"

	D1xD mm	Ø GAS BSP		
1915B 8x12	8x12	1/4"	019150012	€ 29
1915B 11x16	11x16	3/8"	019150013	€ 48



1919L

ISO 32 Ulei

- Special realizat pentru performanță mare la instrumentele de aer
- Bazele de parafină și aditivii speciali permit:
 - Rezistență de neegalat la uzură
 - Rezistență remarcabilă la apă
 - Reziduuri reduse de carbon
 - Punctul de congelare scăzut și rezistență ridicată la rugină



019190050

~~€ 16~~ € 11

Cantitate	cc	500
Densitate 20°C	Kg/m ³	875
Vâscozitate 40°C	cSt	32
Inflamabilitate COC	°C	6,2
Congelare	°C	-33
Greutate	g	620

1916G

Ștuț aer comprimat



1916G 1/4	019160005	€ 1,7
1916G 3/8	019160010	€ 2,3
1916G 1/2	019160012	€ 2,5

1916GFE

Ștuț aer comprimat



1916GFE 1/4	019160075	€ 1,7
1916GFE 3/8	019160082	€ 2,3
1916GFE 1/2	019160084	€ 2,5

1917F

Cuplă aer comprimat



1917F 1/4	019170005	€ 6,5
1917F 1/2	019170014	€ 6,7

1917M

Cuplă aer comprimat



1917M 1/4	019170001	€ 6
1917M 3/8	019170003	€ 6
1917M 1/2	019170004	€ 6,5

1917RG

Cuplă aer comprimat, 1/4', orientabilă 360 grade

019170252

~~€ 19,50~~ € 13,5



1949BC

Pistol de suflat aer comprimat

- Carcasă din plastic rezistent la șocuri
- Duză de cauciuc interschimbabil

019490022

€ 15,30 € 10



Filet de intrare	1/4" GAS
Presiunea de lucru	6-8 bar
Presiunea maxima	15 bar
Consumul mediu de aer	87l/min
Temperatura de lucru	-20°C-70°C

1952

Pistol de vopsit

- Corp de aluminiu placat cu nichel
- Cupla nylon cu filet exterior de 3/8"
- Regulator presiune si debit
- Regulator cantitate vopsea
- Regulator raza jet
- Echipat cu duza conform tabel mai jos



1952 1,2	019520012	€ 133	€ 89
1952 1,5	019520015	€ 133	€ 89
1952 1,8	019520018	€ 133	€ 89
1952 2,0	019520020	€ 133	€ 89

1947H

Pistol pneumatic pentru aplicarea siliconului

- Potrivit pentru silicon și adeziv în tuburi de plastic sau aluminiu
- Valvă de reducere a presiunii incorporată
- Greutate 750g

019470011

€ 200 € 138

Dimensiune tub	mm	210*50
Capacitate tub	ml	300/310
Admisie de aer	GAS	1/4"
Presiunea de lucru	Bar	4-8
Dimensiunea interioară a furtunului (Ø)	mm	2,5
Consumul mediu de aer	l/min	120



1937N10

Polizor pneumatic cu bandă

019370041

€ 257 € 176

Turație liberă	rpm	20000
Putere	kW	0,3
Dimensiune curea	mm	10*330
Admisie de aer	GAS	1/4"
Presiunea de lucru	Bar	6,2
Dimensiunea interioară a furtunului (Ø)	mm	10
Consumul mediu de aer	l/min	374

1937



Mașină de șlefuit, fără lubrifiere, confecționată din material compozit

- Nu necesită lubrifiere
- Extrem de compactă și ușor de manevrat
- Diametrul orbitei: 5 mm
- Disc Velcro cu 6 găuri
- Reglaj continuu al turației motorului
- Mâner din material moale anti-alunecare
- Concepută pentru sisteme de absorbție cu fittinguri oscilante

019370001

€ 383

€ 266

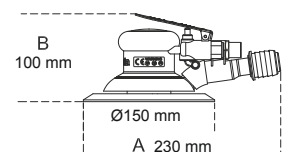

Turație liberă	rpm	12.000
Puterea	kW	0,18
Diametrul discului	mm	150
Diametrul orbitei	mm	5
Filetul axului		5/16"-24
Admisie de aer	GAS	1/4"
Presiunea de lucru	Bar	6,2
Dimensiunea interioară a furtunului (Ø)	mm	10
Consumul mediu de aer	l/min	170

860 g

8153...

UNI EN 1492-1

Chingă de ridicare, capacitate 2T, cu inele ranforsate, fabricată din două straturi de poliester de înaltă densitate

	L mm	H mm	Capacitate		
8153 1	1000	60	2000kg	081530010	€ 7
8153 2	2000	60	2000kg	081530020	€ 11
8153 3	3000	60	2000kg	081530030	€ 15
8153 4	4000	60	2000kg	081530040	€ 19
8153 5	5000	60	2000kg	081530050	€ 23

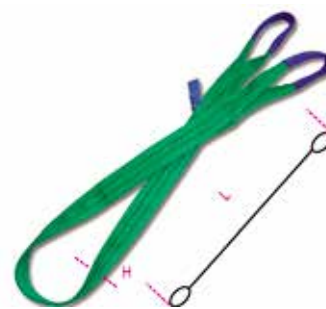

UNI EN 1492-1

8158...

Chingă de ridicare, capacitate 5T, cu inele ranforsate, fabricată din două straturi de poliester de înaltă densitate

	L mm	H mm	Capacitate		
8158 2	2000	150	5000kg	081580020	€ 31
8158 3	3000	150	5000kg	081580030	€ 42
8158 5	5000	150	5000kg	081580050	€ 64



EN 12195-2

PRETURI LA CERERE PENTRU ALTE DIMENSIUNI
SAU CAPACITĂȚI

8181...

Chingă de ancorare cu clichet de strângere, capacitate 1T, fabricată din poliester de înaltă densitate

	L m	L1 mm	L2 mm		
8181 4	6,5	3600	400	081810004	€ 12
8181 6	8,5	5600	400	081810006	€ 14
8181 8	10,5	7600	400	081810008	€ 15

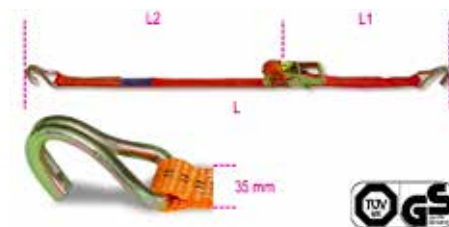

EN 12195-2

8182...

Chingă de ancorare cu clichet de strângere, capacitate 2T, fabricată din poliester de înaltă densitate

	L m	L1 mm	L2 mm		
8182 6,5	6,5	6100	400	081820065	€ 22
8182 8,5	8,5	8100	400	081820085	€ 25
8182 10,5	10,5	10100	400	081820105	€ 28



PENTRU ORICE ALTE DISPOZITIVE DE RIDICARE,
TENSIONARE, ANCORARE,
VĂ RUGĂM VIZITAȚI
WWW.ROBURITALY.COM

Noua familie de produse Beta Abrasives cuprinde o gamă cuprinzătoare de abrazivi duri și flexibili precum și un serviciu tehnic remarcabil pentru profesioniști, ca rezultat al experienței de producție oferite de companiile de top din piață, AbraBeta și Elpa.

11035-11038

TOP
— LINE —

Disc tăiere oțel și inox, subțire, pentru polizor unghiular

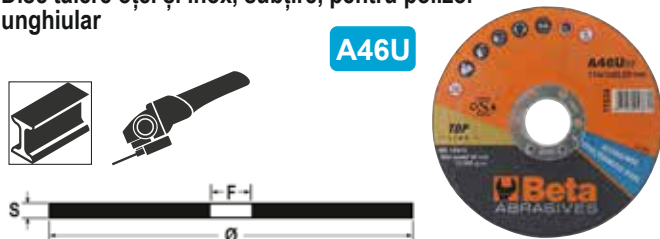

	Ø mm	S mm	F mm			
11035	125	1,0	22,23	110350022	€ 1,50	€ 1,04
11035	125	1,6	22,23	110350062	€ 1,50	€ 1,04
11038	230	2,0	22,23	110380022	€ 2,75	€ 1,90

11210B

PREMIUM
— LINE —

Disc conic lamelar abraziv pentru șlefuit, zirconiu, spate fibră de sticlă, Ø125mm



Ø mm	Granulație	F mm				
125	40	22,23	112100104	€ 2,55	€ 1,76	
125	60	22,23	112100106	€ 2,55	€ 1,76	
125	80	22,23	112100108	€ 2,55	€ 1,76	

11220B

TOP
— LINE —

Disc conic lamelar abraziv pentru șlefuit, zirconiu, spate fibră de sticlă, Ø125mm



Ø mm	Granulație	F mm				
125	40	22,23	112200104	€ 3,15	€ 2,17	
125	60	22,23	112200106	€ 3,15	€ 2,17	
125	80	22,23	112200108	€ 3,15	€ 2,17	

11431

Disc fibră sintetică din corindon, Ø115



Ø mm	Granulație	F mm			
115	C	22,23	114310006	11,30	€ 8
115	M	22,23	114310008	11,30	€ 8
115	F	22,23	114310012	11,30	€ 8
115	VF	22,23	114310024	11,30	€ 8

11259

TOP
— LINE —

Disc lamelar din pâslă, suport fibră de sticlă Ø125mm



Ø mm	S mm	F mm			
125	1,0	22,23	112590115	€ 8,50	€ 6

11271A-11271C

Perie abrazivă, fibră sintetică din corindon cu tijă Ø6mm



11271A

Ø mm	Granulație	h mm			
40	C	20	112710001	€ 4,8	€ 3,36
40	M	20	112710002	€ 4,8	€ 3,36
40	F	20	112710003	€ 4,8	€ 3,36
40	VF	20	112710004	€ 4,8	€ 3,36

11271B

Ø mm	Granulație	h mm			
60	C	30	112710011	€ 5,3	€ 3,71
60	M	30	112710012	€ 5,3	€ 3,71
60	F	30	112710013	€ 5,3	€ 3,71
60	VF	30	112710014	€ 5,3	€ 3,71

11271C

Ø mm	Granulație	h mm			
80	C	50	112710021	€ 5,80	€ 4
80	M	50	112710022	€ 5,80	€ 4
80	F	50	112710023	€ 5,80	€ 4
80	VF	50	112710024	€ 5,80	€ 4

7905G

~~€ 75~~

€ 52

Combinezon de lucru

- confecționate din pânză T/C, 65% poliester, 35% bumbac, 260 g/m²

XS	079050800
S	079050801
M	079050802
L	079050803
XL	079050804
XXL	079050805
XXXL	079050806
XXXXL	079050807



7900G

~~€ 48~~

€ 33

Pantalon de lucru

- confecționate din pânză T/C, 65% poliester, 35% bumbac, 260 g/m²



XS	079000800
S	079000801
M	079000802
L	079000803
XL	079000804
XXL	079000805
XXXL	079000806
XXXXL	079000807

7903G

~~€ 60~~

€ 41

Salopetă de lucru

- confecționate din pânză T/C, 65% poliester, 35% bumbac, 260 g/m²

XS	079030800
S	079030801
M	079030802
L	079030803
XL	079030804
XXL	079030805
XXXL	079030806
XXXXL	079030807



7904N

~~€ 89~~

€ 61

Jachetă de lucru

- confecționată din pânză T/C, 65% poliester, 35% bumbac, 270 g/m²



7907G

~~€ 44,50~~

€ 30,50

Vestă de lucru

- confecționate din pânză T/C, 65% poliester, 35% bumbac, 260 g/m²

XS	079070800
S	079070801
M	079070802
L	079070803
XL	079070804
XXL	079070805
XXXL	079070806
XXXXL	079070807



7909G

~~€ 53~~

€ 36,50

Jachetă de lucru

- confecționate din pânză T/C, 65% poliester, 35% bumbac, 260 g/m²



XS	079040800
S	079040801
M	079040802
L	079040803
XL	079040804
XXL	079040805
XXXL	079040806
XXXXL	079040807

XS	079090800
S	079090801
M	079090802
L	079090803
XL	079090804
XXL	079090805
XXXL	079090806
XXXXL	079090807

7865G

~~€ 69~~ € 47,50

Combinazon de lucru, subtire

• confecționate din pânză T/C, 65% poliester, 35% bumbac, 180 g/m²

XS	078650800
S	078650801
M	078650802
L	078650803
XL	078650804
XXL	078650805
XXXL	078650806
XXXXL	078650807



7860G

~~€ 43,50~~ € 30

Pantaloni de lucru, subtire

• confecționate din pânză T/C, 65% poliester, 35% bumbac, 180 g/m²

XS	078600800
S	078600801
M	078600802
L	078600803
XL	078600804
XXL	078600805
XXXL	078600806
XXXXL	078600807



7863G

~~€ 53~~ € 36,50

Salopetă de lucru, subtire

• confecționate din pânză T/C, 65% poliester, 35% bumbac, 180 g/m²

XS	078630800
S	078630801
M	078630802
L	078630803
XL	078630804
XXL	078630805
XXXL	078630806
XXXXL	078630807



7867G

~~€ 40,50~~ € 28

Vestă de lucru, subtire

• confecționate din pânză T/C, 65% poliester, 35% bumbac, 180 g/m²

XS	078670800
S	078670801
M	078670802
L	078670803
XL	078670804
XXL	078670805
XXXL	078670806
XXXXL	078670807



7861G

~~€ 36,50~~ € 25

Pantaloni scurți, subtiri

• confecționate din pânză T/C, 65% poliester, 35% bumbac, 180 g/m²

XS	078610800
S	078610801
M	078610802
L	078610803
XL	078610804
XXL	078610805
XXXL	078610806
XXXXL	078610807



7869G

~~€ 47,50~~ € 33

Jachetă de lucru, subtire

• confecționate din pânză T/C, 65% poliester, 35% bumbac, 180 g/m²

XS	078690800
S	078690801
M	078690802
L	078690803
XL	078690804
XXL	078690805
XXXL	078690806
XXXXL	078690807



7241EN

~~€ 33~~ € 23

Pantofi din piele naturală, impermeabili, talpă cu protecție antipenetrare

- Bombeu cu protecție din oțel
- Talpă elastică antipenetrare

EU	UK	
35	2,5	072410835
36	3,5	072410836
37	4,5	072410837
38	5	072410838
39	6	072410839
40	6,5	072410840
41	7	072410841
42	8	072410842
43	9	072410843
44	10	072410844
45	10,5	072410845
46	11	072410846
47	12	072410847
48	13	072410848



EN ISO
20345
2011

S1P SRC

7243BK

~~€ 40,50~~ € 28

Ghete din piele naturală, cu talpă antipenetrare și sistem rapid de dezlegare șiret

- Bombeu cu protecție din oțel
- Talpă elastică antipenetrare

EU	UK	
35	2,5	072431235
36	3,5	072431236
37	4,5	072431237
38	5	072431238
39	6	072431239
40	6,5	072431240
41	7	072431241
42	8	072431242
43	9	072431243
44	10	072431244
45	10,5	072431245
46	11	072431246
47	12	072431247
48	13	072431248



EN ISO
20345
2011

S1P RS SRC

7246BK

~~€ 41,50~~ € 28,50

Pantofi piele întoarsă, perforată

- Bombeu cu protecție din oțel
- Talpă elastică antipenetrare

EU	UK	
35	2,5	072461235
36	3,5	072461236
37	4,5	072461237
38	5	072461238
39	6	072461239
40	6,5	072461240
41	7	072461241
42	8	072461242
43	9	072461243
44	10	072461244
45	10,5	072461245
46	11	072461246
47	12	072461247
48	13	072461248



EN ISO
20345
2011

S1P SRC

7216BKK

~~€ 64~~ € 44

Sandale din piele întoarsă, perforate, cu curelușă

- Bombeu din material compozit
- Talpă antipenetrare din fibre compozite

EU	UK	
35	2,5	072160335
36	3,5	072160336
37	4,5	072160337
38	5	072160338
39	6	072160339
40	6,5	072160340
41	7	072160341
42	8	072160342
43	9	072160343
44	10	072160344
45	10,5	072160345
46	11	072160346
47	12	072160347
48	13	072160348



EN ISO
20345
2011

S1P SRC

7357G

~~€ 124~~ € 86

Pantofi de lucru, impermeabili, cu inserții din microfibră

- Bombeu din fibre de sticlă
- Talpă antipenetrare din fibre compozite



EU	UK	
38	5	073570038
39	6	073570039
40	6,5	073570040
41	7	073570041
42	8	073570042
43	9	073570043
44	10	073570044
45	10,5	073570045
46	11	073570046
47	12	073570047
48	13	073570048



480 g

7321NA

~~€ 67~~ € 46

Pantofi de lucru, impermeabili, cu inserții din microfibră

- Bombeu din fibre de sticlă
- Talpă antipenetrare din fibre compozite

EU	UK	
35	2,5	073210435
36	3,5	073210436
37	4,5	073210437
38	5	073210438
39	6	073210439
40	6,5	073210440
41	7	073210441
42	8	073210442
43	9	073210443
44	10	073210444
45	10,5	073210445
46	11	073210446
47	12	073210447
48	13	073210448



EN ISO 20345 2011
S3 RS SRC

7238WR

~~€ 83,50~~ € 57

Pantofi de lucru, perforati, cu inserții din pânză, aerisiți

- Bombeu din material compozit
- Talpă antipenetrare din fibre compozite

EU	UK	
35	2,5	072380235
36	3,5	072380236
37	4,5	072380237
38	5	072380238
39	6	072380239
40	6,5	072380240
41	7	072380241
42	8	072380242
43	9	072380243
44	10	072380244
45	10,5	072380245
46	11	072380246
47	12	072380247
48	13	072380248



Endurance



7317NA

~~€ 62~~ € 43

Pantofi de lucru, impermeabili

- Bombeu din material compozit
- Talpă antipenetrare din fibre compozite

EU	UK	
35	2,5	073170135
36	3,5	073170136
37	4,5	073170137
38	5	073170138
39	6	073170139
40	6,5	073170140
41	7	073170141
42	8	073170142
43	9	073170143
44	10	073170144
45	10,5	073170145
46	11	073170146
47	12	073170147
48	13	073170148



EN ISO 20345 2011
S3 SRC

7577N

~~€ 48,50~~ € 33

Vestă de lucru

- 100% poliester microfibre 50D
- Căptușeală din poliester, 160 g / m²
- Două buzunare în talie cu închidere cu fermoar
- Două buzunare interioare



XS	075770000
S	075770001
M	075770002
L	075770003
XL	075770004
XXL	075770005
XXXL	075770006

7840BL

~~€ 33,50~~ € 23

Pantaloni de lucru, cu buzunare multiple

- pânză răsucită T/C , 65% poliester, 35% bumbac, 240 g/m²
- Buzunar mare lateral stânga
- Două buzunare spate



XS	078400100
S	078400101
M	078400102
L	078400103
XL	078400104
XXL	078400105
XXXL	078400106
XXXXL	078400107

7528

~~€ 49,50~~ € 34

Pantaloni de lucru, din bumbac denim supraelastic

- 2% material supraelastic 98% bumbac
- 2 buzunare frontale
- 2 buzunare în spate
- Buzunar mare lateral stânga



XS	075280046
S	075280048
M	075280050
L	075280052
XL	075280054
XXL	075280056
XXXL	075280058

9563U

095630020

~~€ 285~~ € 197

Scaun birou



9549BP

095490052

~~€ 18,50~~ € 12,50

Baterie portabilă, ultrasubțire, 10000 mA



9549C

095490062

~~€ 12,5~~ € 8,5

Stick USB , 32gb





LOGISTICĂ

Livrare rapidă și
completă
a comenzilor dvs.

Spațiu de depozitare și
pregătire a comenzilor
de peste 15,000 m²



Stoc cu peste 12.000
de repere diferite



Partnership 2021



Jorge Navarro
Moto2 World Championship



Prețurile sunt exprimate în EURO și nu conțin TVA
Imaginile sunt cu titlu de prezentare.

Beta Utensili S.p.A. își rezervă dreptul de a schimba sau modifica produsele fără notificare.